

Nantes Park

Walkway Improvements and Temporary Art Installation

Presented by Seattle-Nantes Sister City Association (SNSCA)

seattlenantesSCA@gmail.com

www.seattle-nantes.org

Seattle - Nantes



Sister City Association

This document has been funded in part by the Neighborhood Matching Fund Program of the Seattle Department of Neighborhoods. The information contained herein does not necessarily reflect the policies, plans, beliefs, conclusions, or ideas of the City of Seattle.

Nantes Park and the Seattle-Nantes Sister City Association



- 1980: Sister city relationship established and the Seattle-Nantes Sister City Association (SNSCA) formed.
 - SNSCA is a non-profit dedicated to advancing cultural and educational relations between our two cities.
 - SNSCA has awarded 80 scholarships in the last 30 years to WA students studying French.
- 2006: Nantes Park inaugurated with gift of magnolia tree from the City of Nantes.
- SNSCA organizes twice a year community weeding events.
- Grant for additional plants in 2011 from the West Seattle Garden Tour.

Seattle - Nantes



Sister City Association

Introduction

Nantes Park Sister City Walkway & Temporary Art Installation

Community Mtg #1

The
West
Studio





Inclusive Layout



Alki Substation Park
Current Project
Site Plan

January 27, 2004



Loop Walking Path
w/ Interval Seating

Open Lawn Area

Contemplative Areas

Delineated Entry

Seattle-Nantes



Sister City Association

Original Plan

Nantes Park Sister City Walkway & Temporary Art Installation

Community Mtg #1

The West
Studio

PROJECT STARTS WITH ONLINE SURVEY

- Posted on the West Seattle Blog
- 119 responses in 2 days on 7/5 and 7/6 2019.
- 49% have never visited the park
- 42% visit a few times a month or a year
- 9% go once a week or more

4. If you don't visit Nantes Park, why not?



- Don't know it's there or know anything about it



- Not inviting, no incentive to stop

- Don't know anything about the park
- Nothing special/unique to see/do
- Nothing for kids to play on
- No shade
- Feels like a lawn that belongs to the neighbors
- High traffic / loud road noise
- No parking

5. What changes to Nantes Park would encourage you to visit more often?

Answered: 96 Skipped: 23

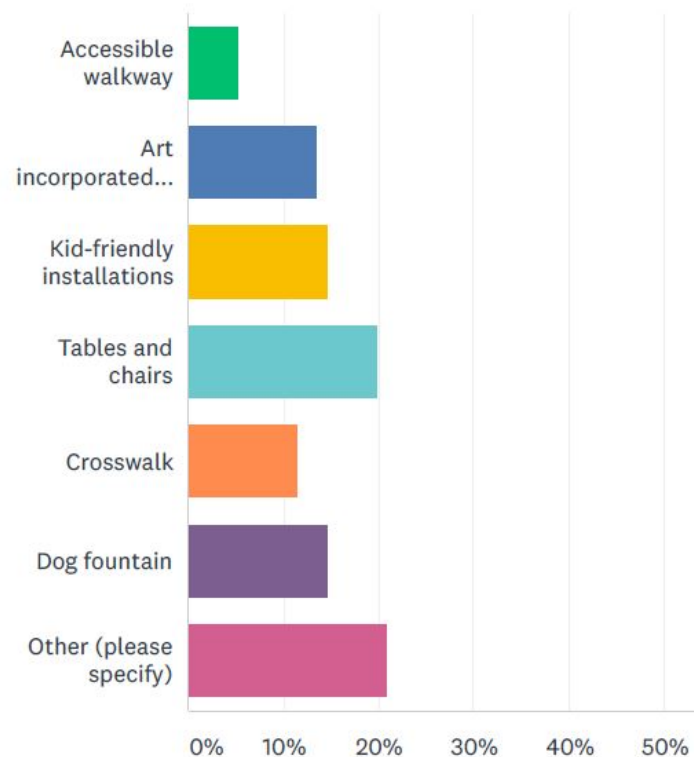

• Other comments:

- **Focal feature**
- **More sense of French!**
- **Need to emphasize connection to Nantes/France**
- Pollinator and bird friendly plants and flowers.
- Shade trees
- Dog park
- Bike parking
- Pickleball court
- Urban forest
- Water fountain

NEXT STEP – SECURING FUNDING, DESIGNS



- **Summer 2019:** SNSCA starts planning 40th anniversary celebration in Nantes Park for Fall 2020
- **Feb 2020:** DON grant to create conceptual designs
- **Feb 2020:** WSGT grant for art tiles on seat wall
- **April 2020:** Conceptual design, Covid intervenes
- **Nov 2020:** DON grant to implement chosen conceptual design for postponed 40th anniversary celebration
- **Dec 2020:** Nantes awards funds for French design



DON = Seattle Department of Neighborhoods
WSGT = West Seattle Garden Tour

FINAL DESIGN CHOICES AND IMPLEMENTATION



The project will transform a small, rarely used pocket park, located at 5062 SW Admiral Way Seattle WA, into something that is fun, family-friendly, accessible, and reflective of the sister city relationship with Nantes, France.



Connecting to Nantes through Shared Art – Claude Ponti



- SNSCA has partnered with **Claude Ponti**, beloved French children’s author and illustrator, to develop conceptual art installations.
- Ponti has created 12 art installations in parks throughout Nantes and authored 70+ books.
- His most recent project was a collaboration with Musée d’Orsay for a 2020 exhibit “*The Land of Monsters*”.

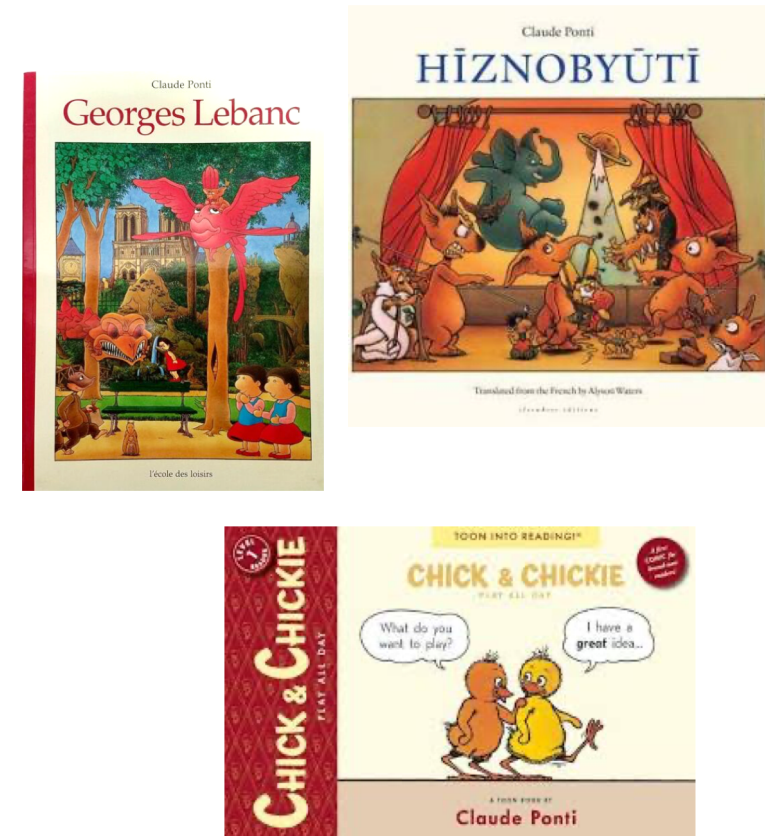

Pot-à-Porte (Door Pots)

Le Jardin des Plantes, Nantes, France



Sketch by Claude Ponti



Seattle-Nantes



Sister City Association

Inspiration 1: Pot-à-Porte

Nantes Park Sister City Walkway & Temporary Art Installation

Community Mtg #1

The West Studio



Concept 1 and 2: Interactive Features

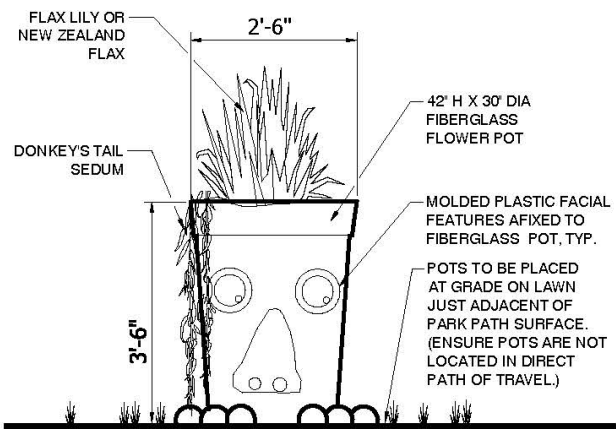

1 CONCEPTUAL DESIGN: POT-A-PORT @ GRADE
3/4" = 1'-0" W-PR-02

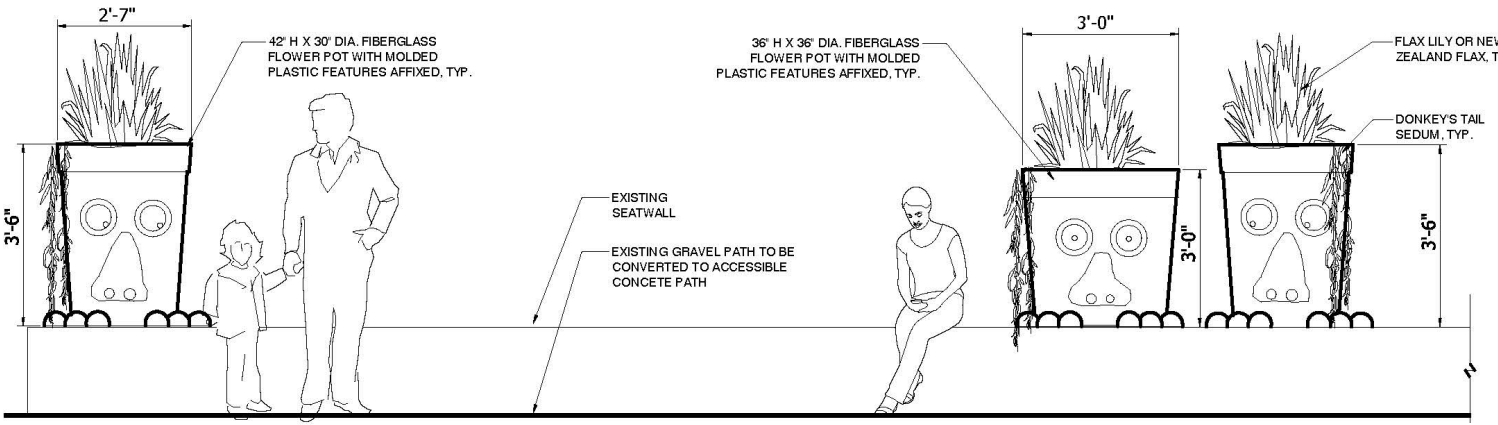

2 CONCEPTUAL DESIGN: POT-A-PORTES ON SEAT WALL
3/4" = 1'-0" W-PR-04



Alki Substation Park
Current Project
Site Plan
January 27, 2004



Concept 1 and 2: Inspired by Pot-à-Porte

Nantes Park Sister City Walkway & Temporary Art Installation Community Mtg #1



Plant Mimicry

Le Jardin des Plantes, Nantes, France



Sketch by Claude Ponti



Concept 3 - Focal Feature

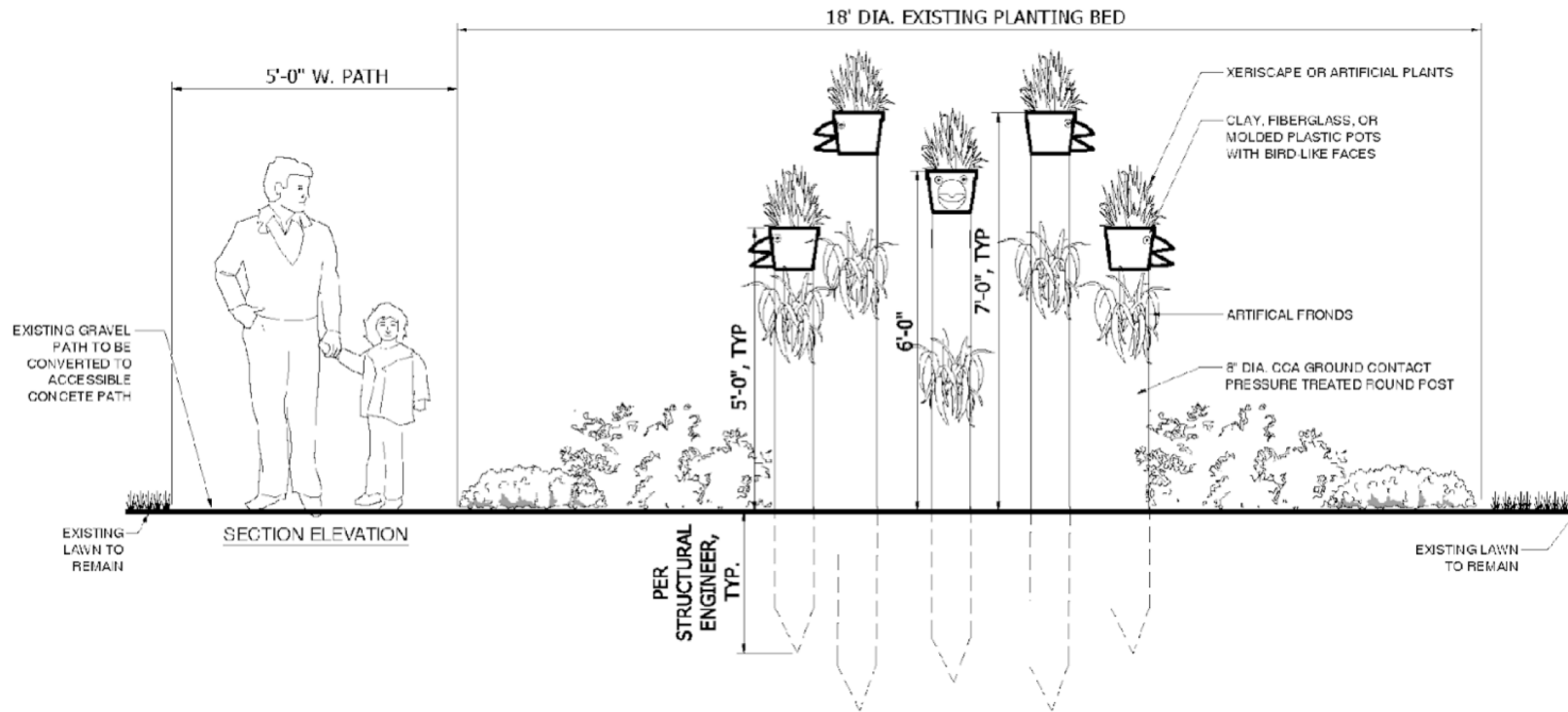

3 CONCEPTUAL DESIGN: LES TOTEMMIQUES
3/4" = 1' 0"

W-PR-05



Concept 3: Plant Mimicry

Nantes Park Sister City Walkway & Temporary Art Installation Community Mtg #1





Donkey's Tail Sedum



Blue Chalk Stick



Flax Lily



Bear Grass



Extremely drought tolerant plants

Walkway

- **Pave** original 2004 walkway for accessibility and maintainability
- **Embed art** designed by Claude Ponti to unfurl as one walks along
- City of Nantes is partially funding the new design!



Walkway Art – Creature Antics

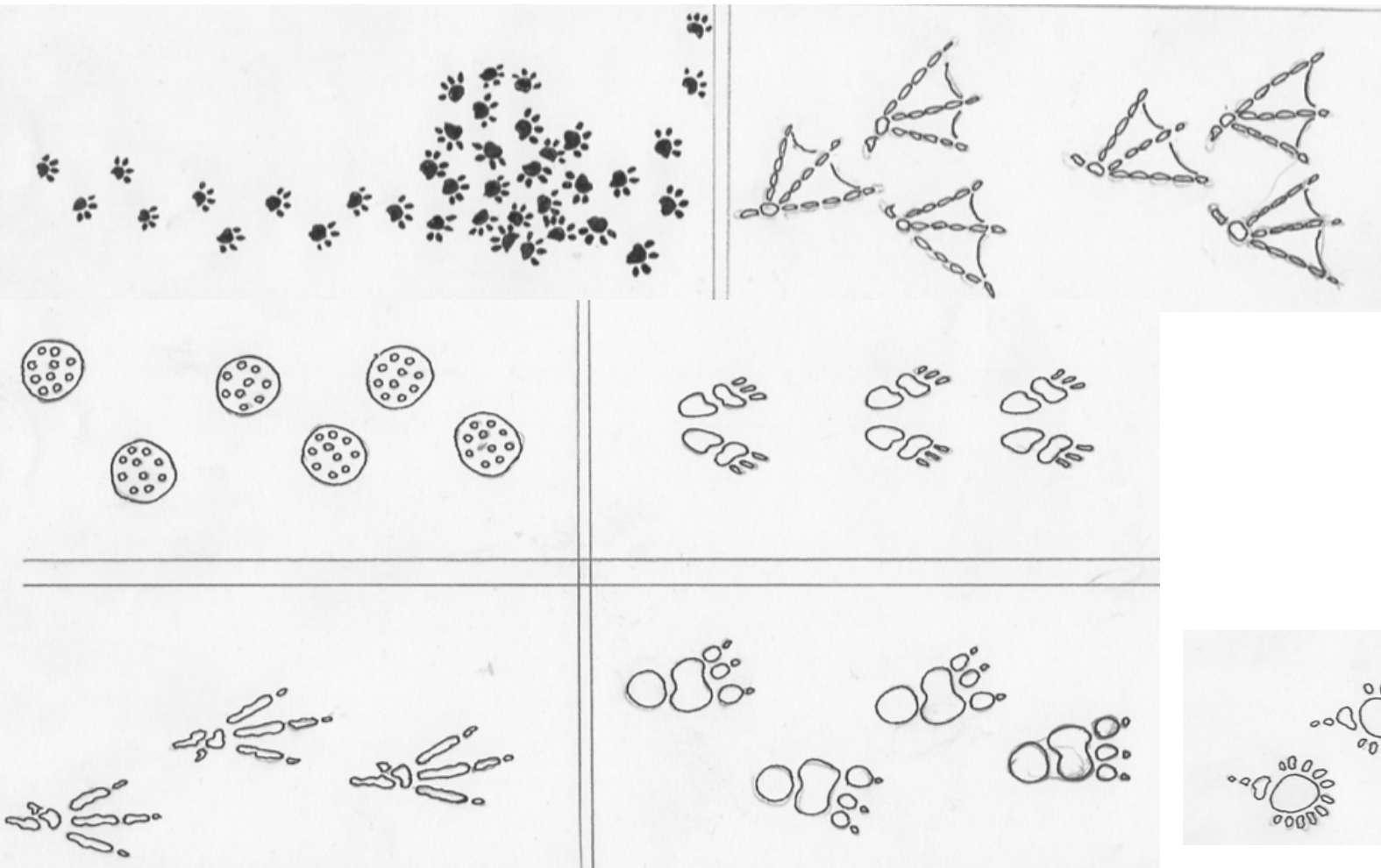

Follow the footprints into the hole

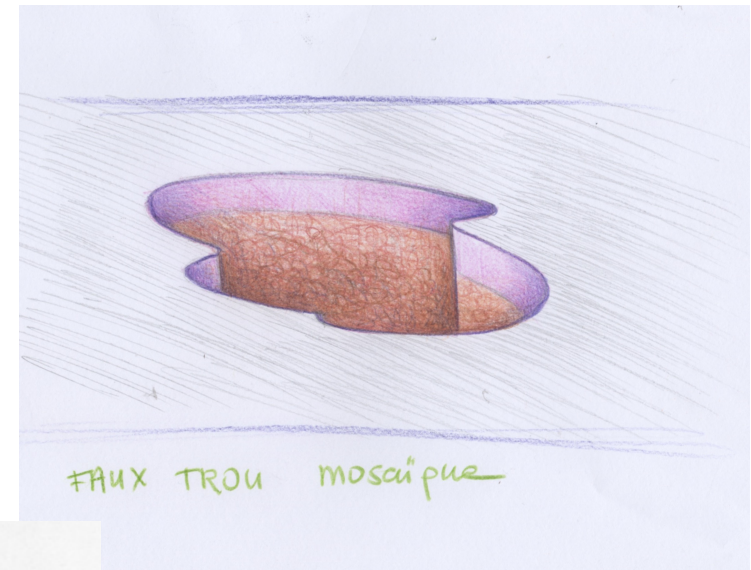

Trompe-l'oeil Hole

BRONZE INLAY FOOTPRINTS IN NEW CIP CONCRETE PATH



INLAY FOOTPRINTS IN NEW CIP CONCRETE PATH



BRONZE INLAY TEXT IN NEW CIP CONCRETE PATH

CHAT
JOYEUX

GOINFRE
GROGNON



SAUTE
RUISSEAU

TRUCHE
INVISIBLE

CANARD
TROIS PIEDS



CHALK SIDEWALK ART ON CONCRETE PATH

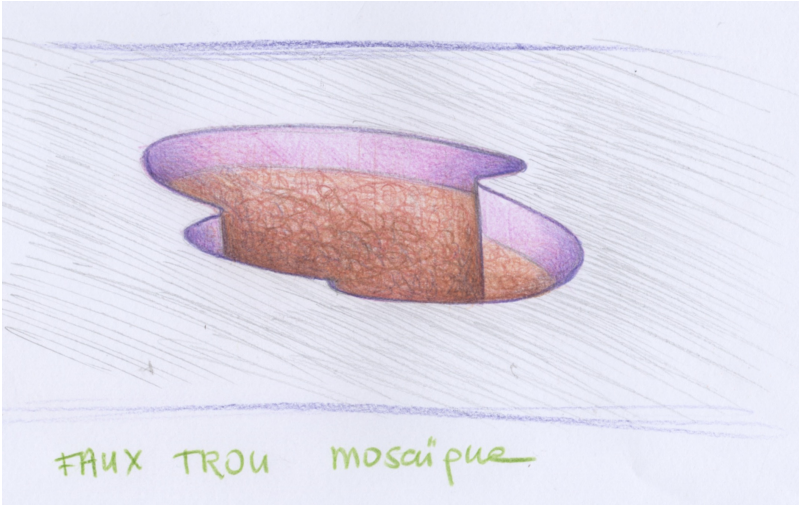

Artist hired to create unique whimsical “hole” designs for special park events.



Character Footprint and Location Choices

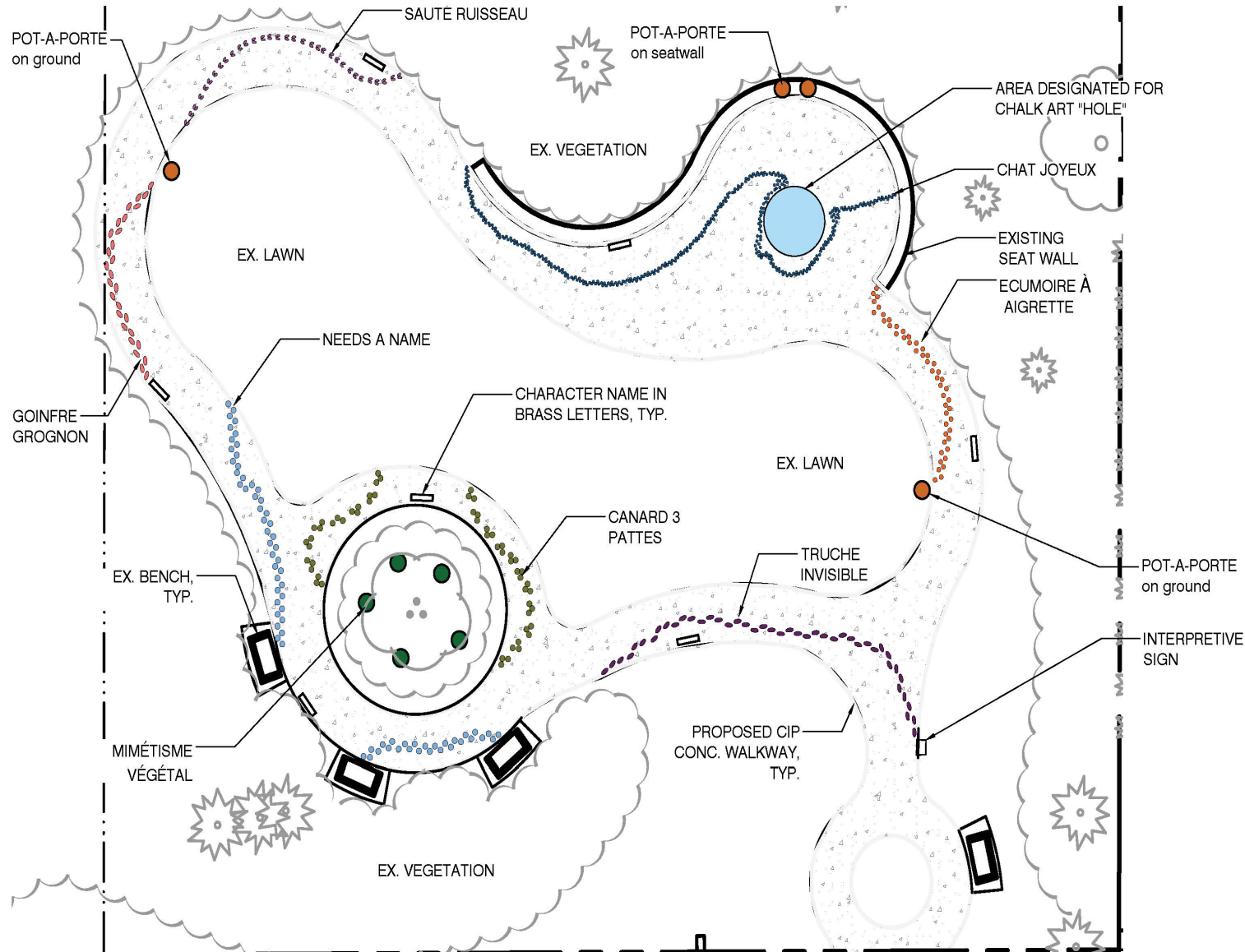

Layout Options of Park Elements

Seat Wall Art Tiles

- WSGT grant awarded for art tiles on seat wall
- Designs from students in Nantes and Seattle
 - West Seattle HS
 - Bishop Blanchet HS



WEST SEATTLE
GARDEN TOUR
growing community since 1995



Telling the Story

- Interpretive signage
 - Tell the Sister City Story and
 - Explain the art connection
 - Provide a key to the character footprint antics



RANK THE CHOICES

Rate the sculpture choices from 1 (highest) to 3 (lowest) on the survey.

Rate the walkway choices from 1 (highest) to 2 (lowest) on the survey.

Ratings based on preference, not on implementation issues

GIVE US SOME DETAILS

Add your comments and suggestions.

We want to hear from everyone. Link to survey is in the chat.

To see the chat, click on the speech bubble icon on the bottom of your screen.

You can finish offline if you prefer.