



2.0 CONTENTS	2
3.0 PROJECT DATA	3
4.0 SURVEY	4
5.0 URBAN DESIGN ANALYSIS	5
urban context - walkability & transit	
local amenities	
site zoning 3x3 block vicinity	
existing urban context	
material context	
street montages + uses	
site photos & sections	
6.0 COMMUNITY OUTREACH	16
7.0 ZONING DATA	18
8.0 DESIGN GUIDELINES	20
9.0 DESIGN CONCEPTS & INSPIRATION	22
10.0 ARCHITECTURAL DESIGN CONCEPTS	25
comparisons	
scheme 1 : hinge	
scheme 2 : dado	
scheme 3 : interlock	
landscape design concept	
requested departures	
material explorations	
blank facade explorations	
11.0 DESIGN SUMMARY	45

PROJECT INFORMATION

site address	3405/3411/3417 Harbor Ave SW
parcel numbers	7987400130, 7987400140, 7987400150
project number	3034147-EG

PROJECT TEAM

architect	atelier drome architecture 112 prefontaine pl s seattle, wa 98104
contact	michelle linden michelle@atelierdrome.com
builder	STS Construction

PROJECT CRITERIA

zoning	C1-55 (M)
overlays	outer transitional surface parking flexibility
abutting zones	IG2 U/85 (east) SF5000 (west)
current use	(1) existing office building
lot area	3405 Harbor Ave: 3,957 sf 3411 Harbor Ave: 3,957 sf 3417 Harbor Ave: 7,918 sf 15,832 sf TOTAL
allowable FAR	59,370.6sf (3.75)
ECAs	40% steep slope, potential slide, liquefaction, landfill
parking	44 stalls required

PROJECT PROPOSAL

gross building floor area	59,497 sf
proposed residential area	47,538 sf
proposed residential units	126 units (preferred scheme)
proposed parking	71 stalls (preferred scheme)
no. of stories	5 stories of residential with 1 partially below-grade level of parking
demolition	existing office building to be demolished

CONTEXT + SITE

The neighborhood is in transition, with most of the new development occurring as new, higher density residential units. The majority of the commercial activity is across Harbor Ave SW in the industrial zone. On the west side of the site is a smaller scale, single family residential neighborhood. The steep slope of the lot in the east/west direction provides opportunity for views across the industrial zone to the east, towards the Duwamish Waterway and the downtown skyline. It also allows for reduced massing in deference to the single family homes. The site will be shaded from the sun by the hillside to the west at varying times of day throughout the year. Morning sun will be most consistent throughout the day and year as there are no buildings or landscape immediately blocking the light.

The site is well served by transit in the north-south direction, providing connections to Alki, downtown Seattle, and beyond. Public bus, bicycle, and main vehicular routes are provided immediately adjacent to the site along Harbor Ave, with a pedestrian bike/walking path across the street on Harbor Ave. The pedestrian bike path on the east side of Harbor Ave also affords easy access to Alki and the passenger ferry terminal. There is a pedestrian hillclimb stair connecting the residential neighborhoods to the southwest. Bridge access is directly to the south, allowing quick vehicular and bus access to downtown Seattle.

DEVELOPMENT PROPOSAL

This project proposes to create a multi-family building with 5 stories of apartments over 1 partially below grade story of parking. The existing office building will be demolished.

DEVELOPMENT OBJECTIVES

- objective 1: provide modulated massing to create a respectful transition between zones
- objective 2: maximize light and views
- objective 3: provide comfortable and economic housing for a growing neighborhood, in a growing city

4.0 SURVEY | existing conditions

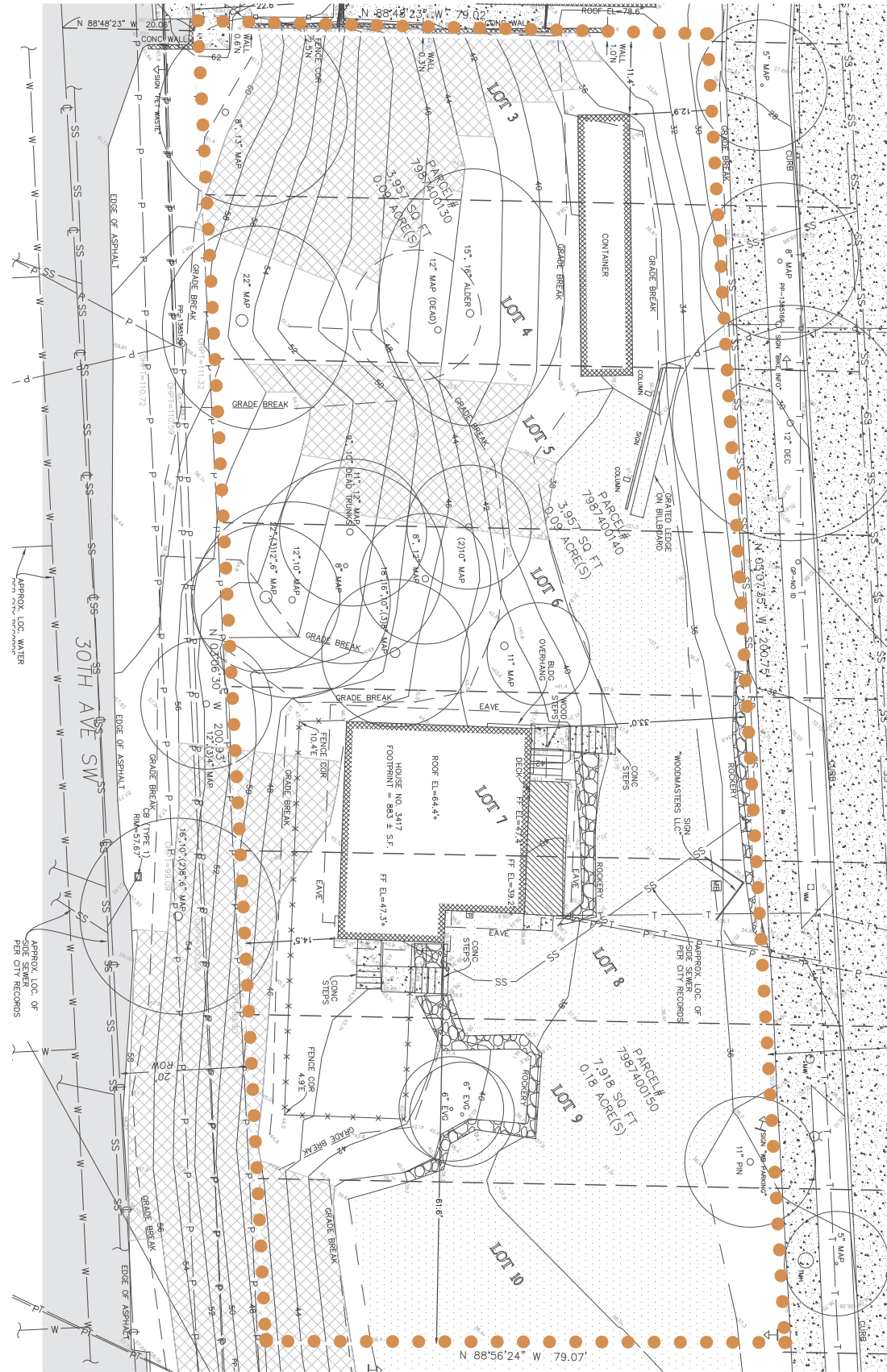

LEGAL DESCRIPTION

Parcel A: Lots 3 and 4, Block 3, Steel Works Addition to West Seattle, according to the plat thereof recorded in Volume 12 of Plats, page 5, in King County, Washington.

Except that portion thereof condemned in King County Superior Court Case cause no. 142193 for Harbor Avenue Southwest, as provided by Ordinance No. 39368 of the City of Seattle.

Parcel B: Lots 5 and 6, Block 3, Steel Works Addition to West Seattle, according to the plat thereof recorded in Volume 12 of Plats, page 5, in King County, Washington.

Except that portion lying east of the line 20 feet west from and parallel with the west margin of Harbor Ave Southwest as condemned under Superior Court Case cause no. 142193.

(Per statutory warranty deed recording #20000315000212)





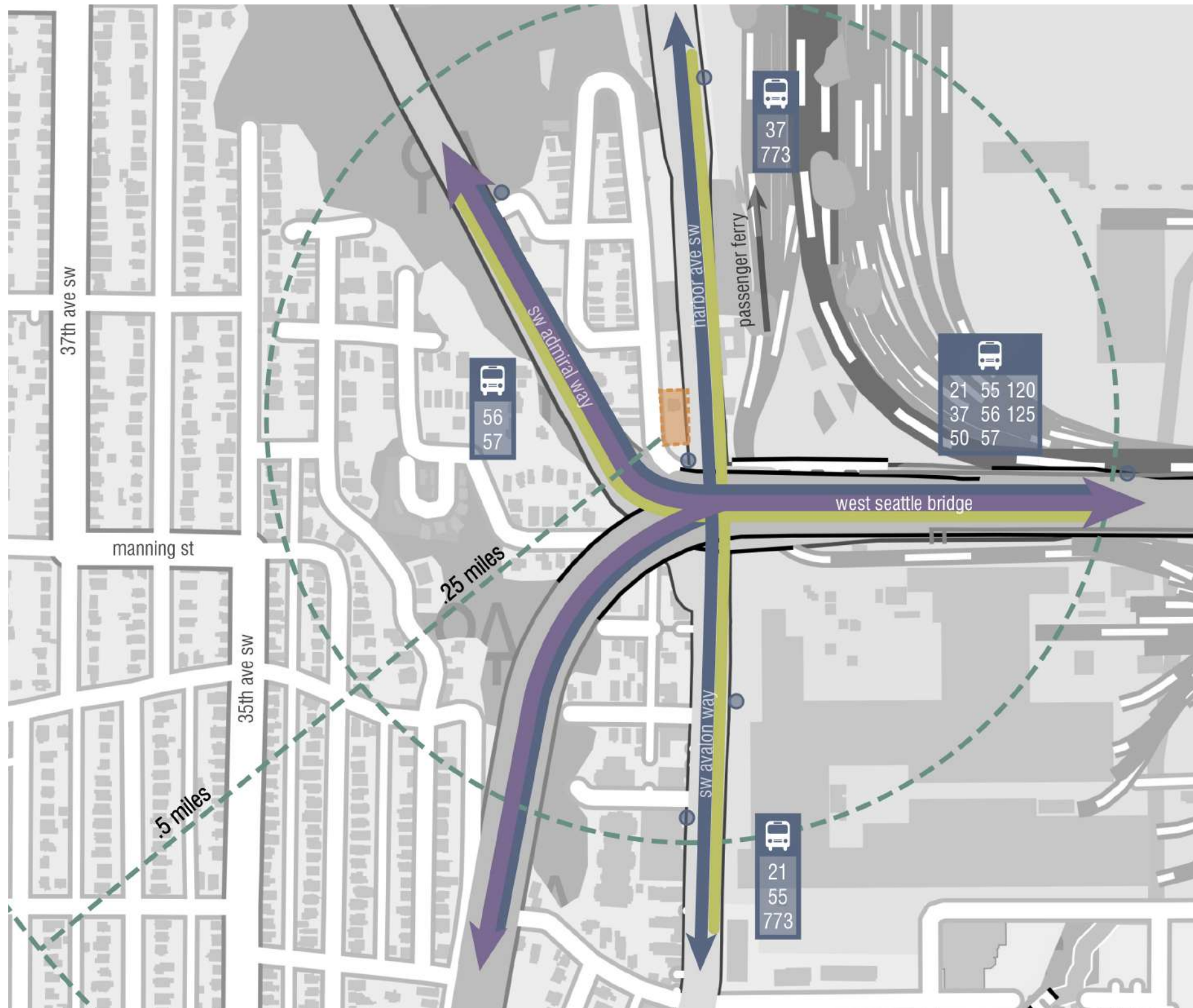

Parcel C: Lots 7,8,9 and 10, Block 3, Steel Works Addition to West Seattle, according to the plat thereof recorded in Volume 12 of Plats, page 5, in King County, Washington.

Except the east 20 feet thereof condemned under King County Superior Court Case cause no. 142193, for street purpose.

Situate in the City of Seattle, County of King, State of Washington.



LEGEND

-  project site
-  arterials
-  bus route
-  bus stop
-  bike path
-  walking radius





LOCAL AMENITIES

- 1** project site
- 2** luna park cafe
- 3** west seattle branch public library
- 4** delridge community center
- 5** pathfinder k-8 school
- 6** west seattle high
- 7** lafayette elementary
- 8** madison middle school
- 9** west seattle stadium
- 10** dragonfly garden
- 11** delridge playfield
- 12** puget park
- 13** hiawatha playfield
- 14** jack block park
- 15** chi franciscan health
- 16** trader joe's
- 17** qfc
- 18** safeway
- 19** metropolitan market
- 20** whole foods
- 21** safeway
- 22** chase bank
- 23** wells fargo bank
- 24** umpqua bank
- 25** bank of america
- 26** becu

SITE ZONING

The site is located in a strip of a commercial zone (C1-55 M), bordered by an industrial zone (IG2-U/85) to the east and single-family zoning (SF5000) to the west.

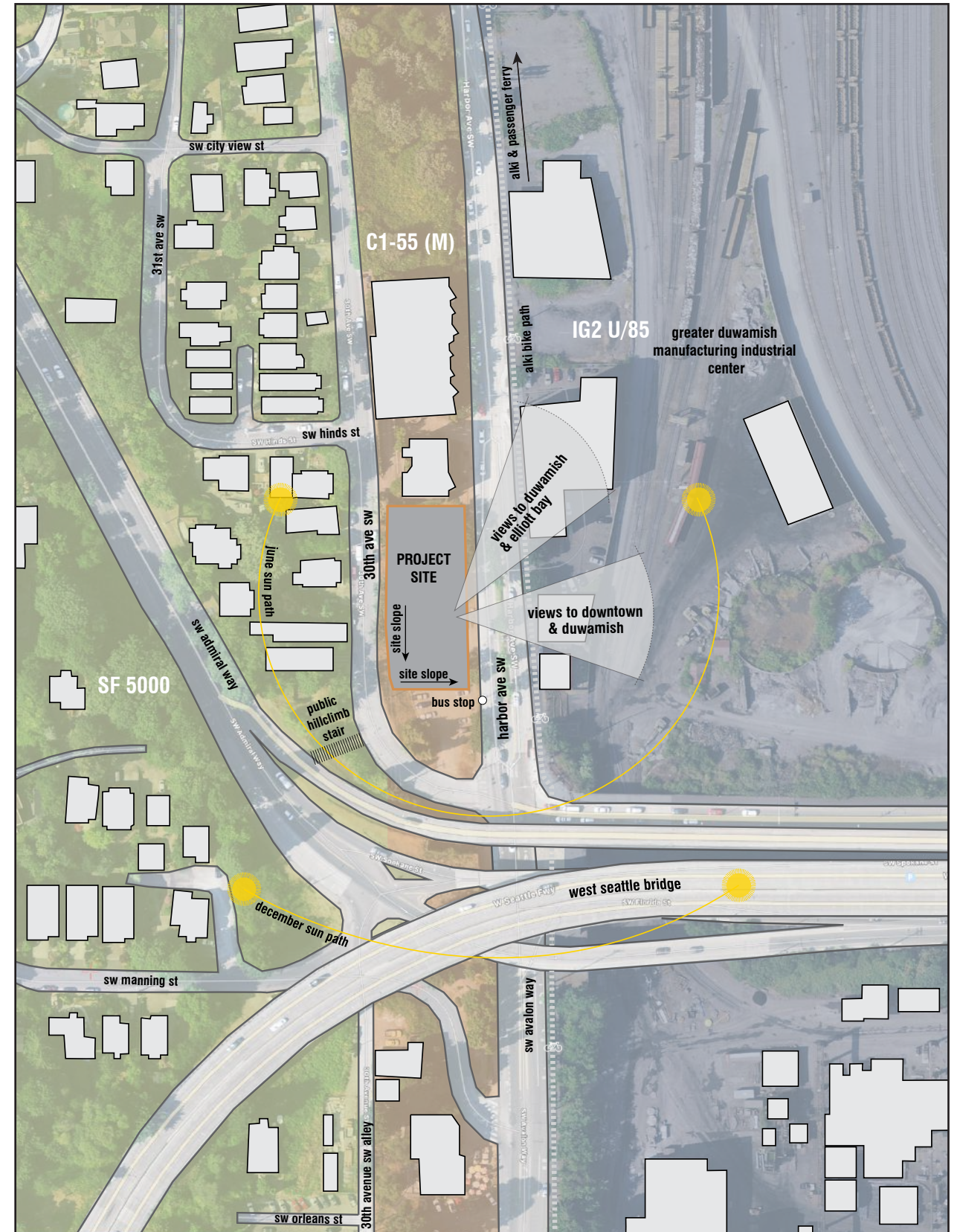
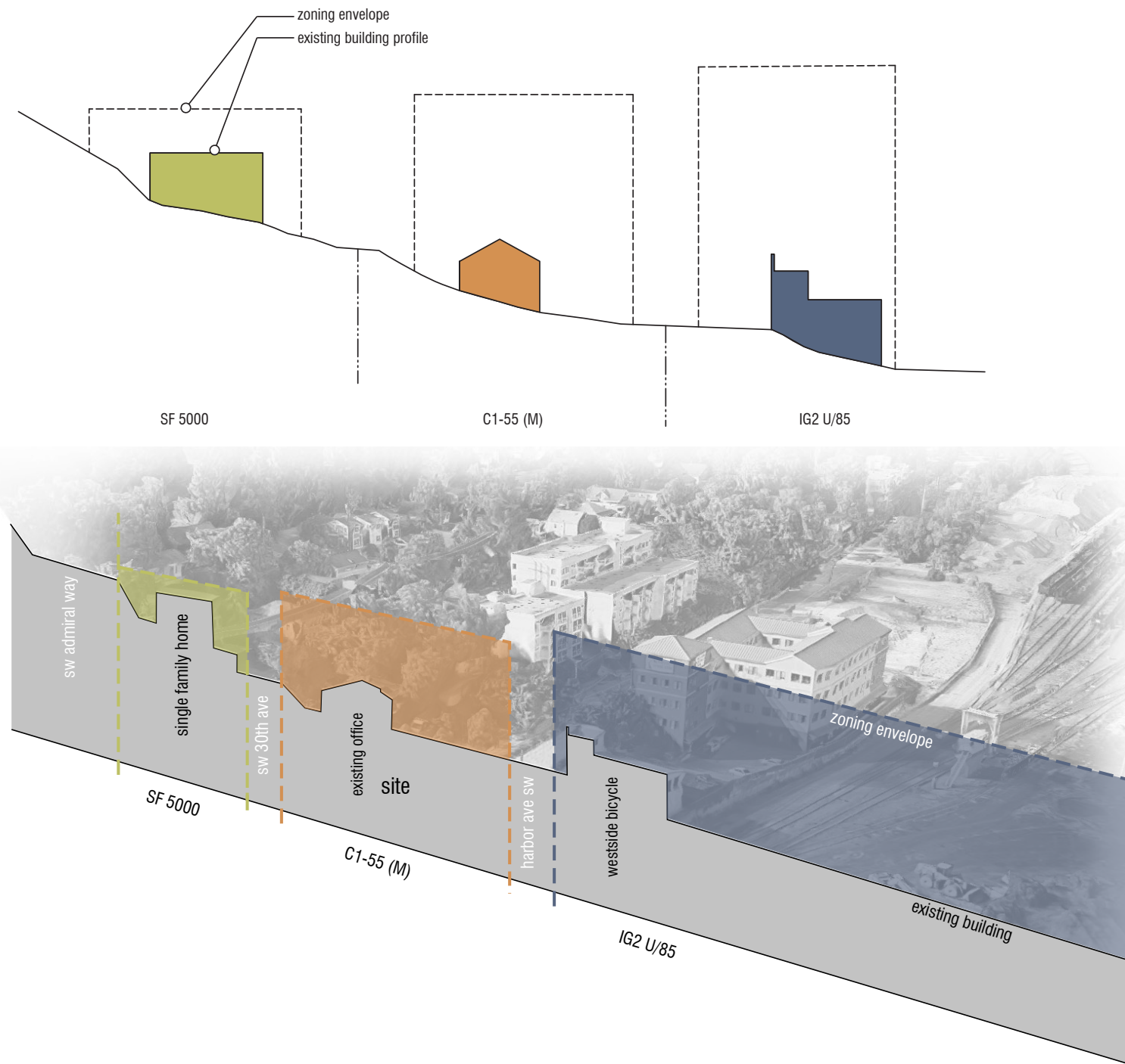

PROJECT LOCATION KEY



1. harbor place condos



2. harbor place condos



3. proposed townhomes



4. 3421 30th ave sw



5. 3411 30th ave sw



6. 3405 30th ave sw



7. activspace



8. westside bicycle



9. emerald city kitty harbor

MATERIAL CONTEXT

With the enormous difference in building scales and uses present in the neighborhood, the material palette and compositions vary widely. There are several key themes this project proposes to use to guide the mass and facade development.

modulation, material choices, and glazing patterns switch from mass to mass, providing visual interest



playful form

modulation and glazing in upper levels

solid base



plinth-like base, strong verticality

verticality is expressed across building scales



strong verticality, residential scale materials

use of residential scale materials

variations in materials accentuate plane changes and break down the mass of a long facade



material changes, strong verticality, residential scale materials, plinth-like base

base clearly expressed with differing materials and colors



material separation at base

5.0 URBAN DESIGN ANALYSIS | street montages & uses

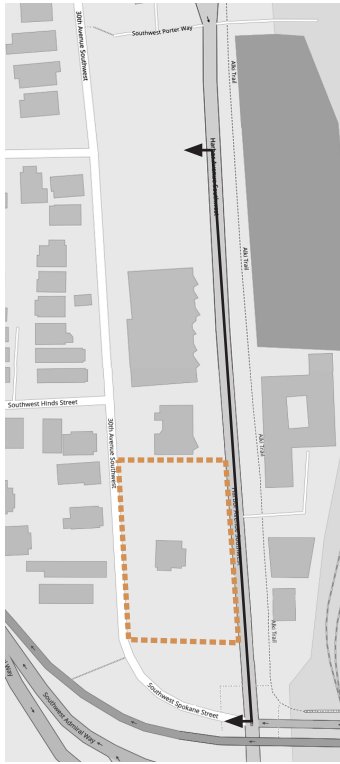

The adjacent site is owned by SPU and will most likely remain undeveloped with only surface improvements in the near future. This creates the feel of a corner lot condition.



The existing multi-family structure and proposed townhomes both embrace verticality over a plinth-like base



Many of the lots along this stretch of Harbor Ave are currently underdeveloped or vacant - leaving stretches of overgrown landscape. Some lots are intended to be developed prior to the completion of this project.

STREETSCAPE ON HARBOR AVE



PROJECT SITE

multi-family

proposed multi-family

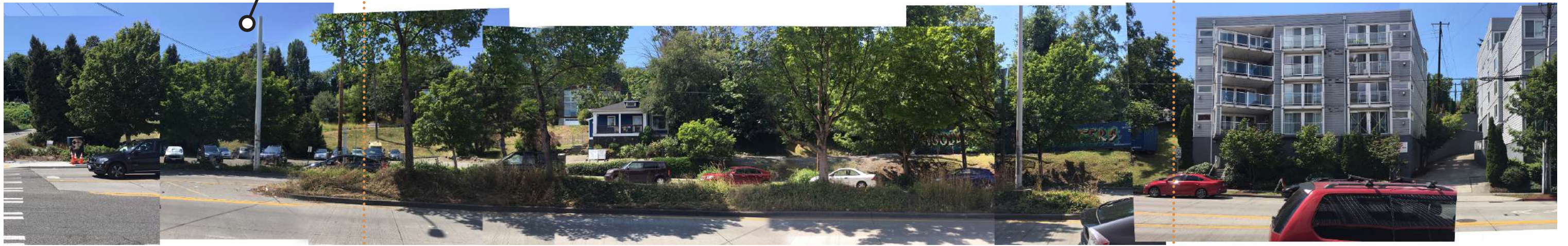

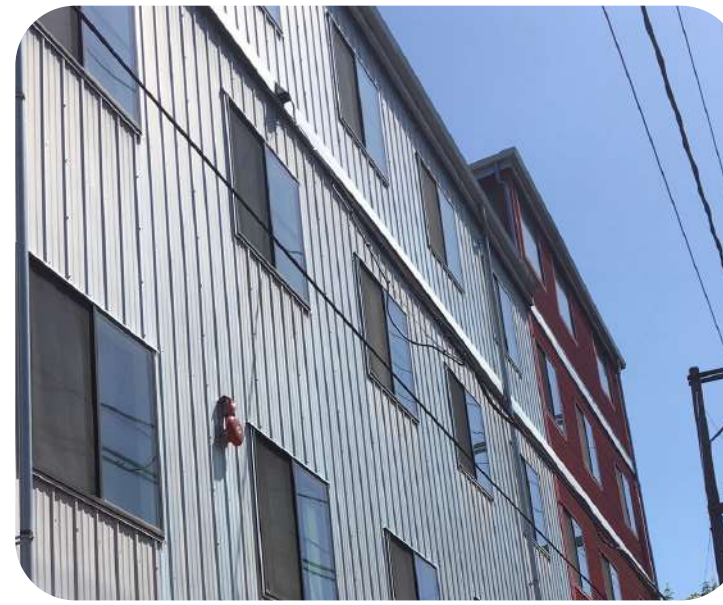
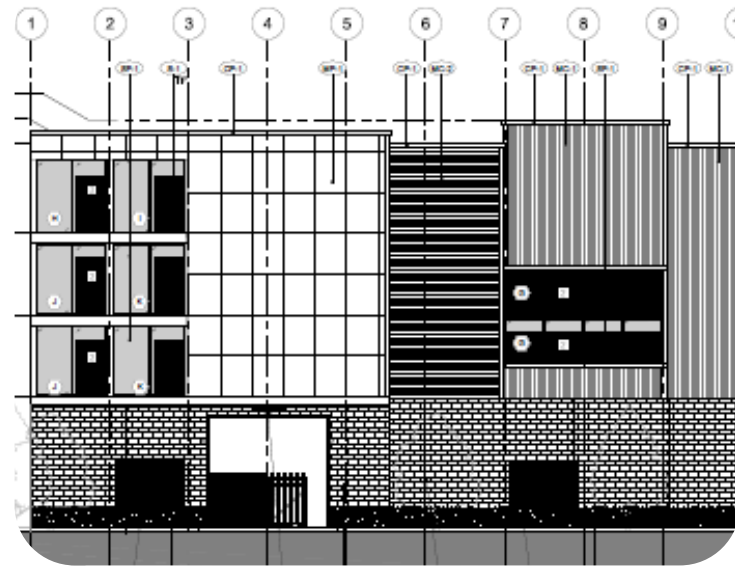
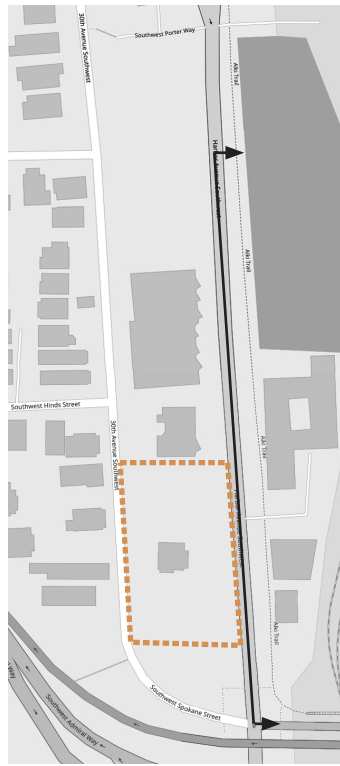

The new proposed storage facility under construction breaks up the massing with a variety of materials that echo the industrial nature of the neighborhood

The existing commercial buildings use a strong and simple design rhythm, using limited materials and repeated window shapes.

Not all of the existing commercial takes full advantage of the zoning potential and may be further developed in the future, changing the streetscape and blocking views.

OPPOSITE ON HARBOR AVE

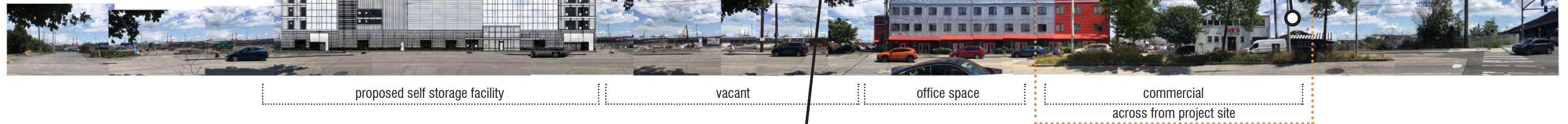

5.0 URBAN DESIGN ANALYSIS | street montages & uses

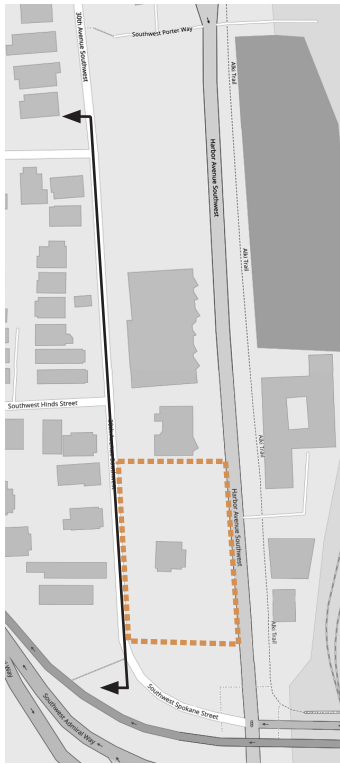

A pedestrian stair connects 30th Ave to SW Admiral Way and provides a viewpoint towards downtown.



Much of the existing single family residential is an eclectic mix of styles and materials.



Modern construction uses materials that evoke the industrial structures common in the neighborhood at a residential scale.

STREETSCAPE ON 30TH AVE



single family residences across from project site

single family residences



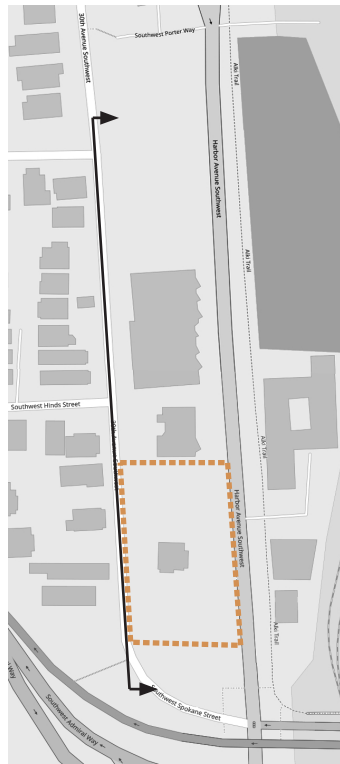

Proposed development along 30th Ave will contribute to changes in the character of 30th Ave.

The existing and proposed multi-family structures fronting 30th Ave have reduced their verticality compared to the Harbor Ave frontages and provided design elements at a more residential scale with a reduced perceived height.

The grade drops sharply at the edge of 30th Ave, creating an unusual topographic challenge.

OPPOSITE ON 30TH AVE



The immediately adjacent structure has a mainly blank facade fronting 30th ave

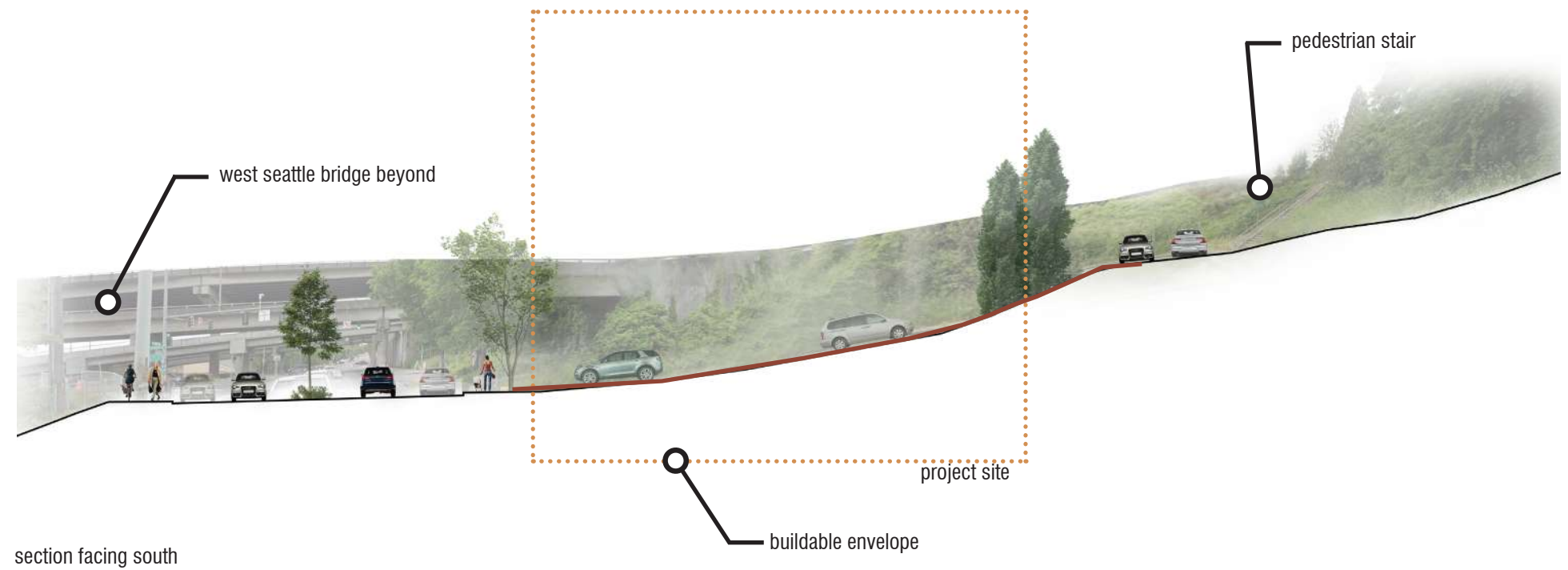
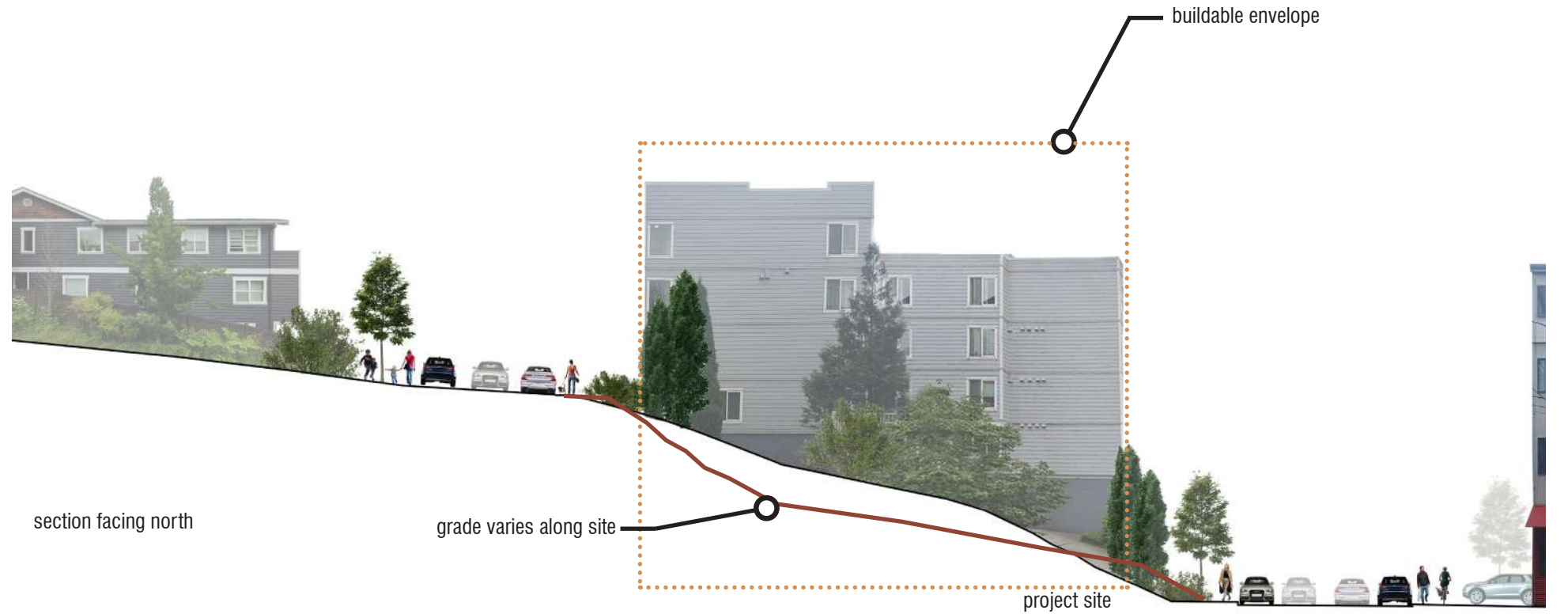



1 view towards West Seattle Bridge



2 view up towards 30th Ave



3 view up to site from Harbor Ave



4 view down to site from 30th Ave



5 view down to site from 30th Ave

OUTREACH METHODS

As part of the community outreach program, the design team chose the following three methods of outreach:

PRINTED OUTREACH:

Posters were hung in ten locations at local businesses, community centers, and local venues within a half-mile of the project site. The posters provided a basic description of the project and advertised an up-coming community meeting.

ELECTRONIC/DIGITAL OUTREACH:

The posters hung within community venues publicized a hotline number community members could use to request more information. The hotline provided a personalized voice message with information about the site location, brief project description, information about the up-coming community meeting, project email address, and the ability to leave a voicemail. The voicemail box was checked daily and any messages left were returned.

IN-PERSON OUTREACH:

A community meeting was hosted at the Hiawatha Community Center, as publicized in the printed and electronic/digital outreach methods. The meeting allowed the community members to provide insight and feedback to the project team. Approximately ten community members participated.

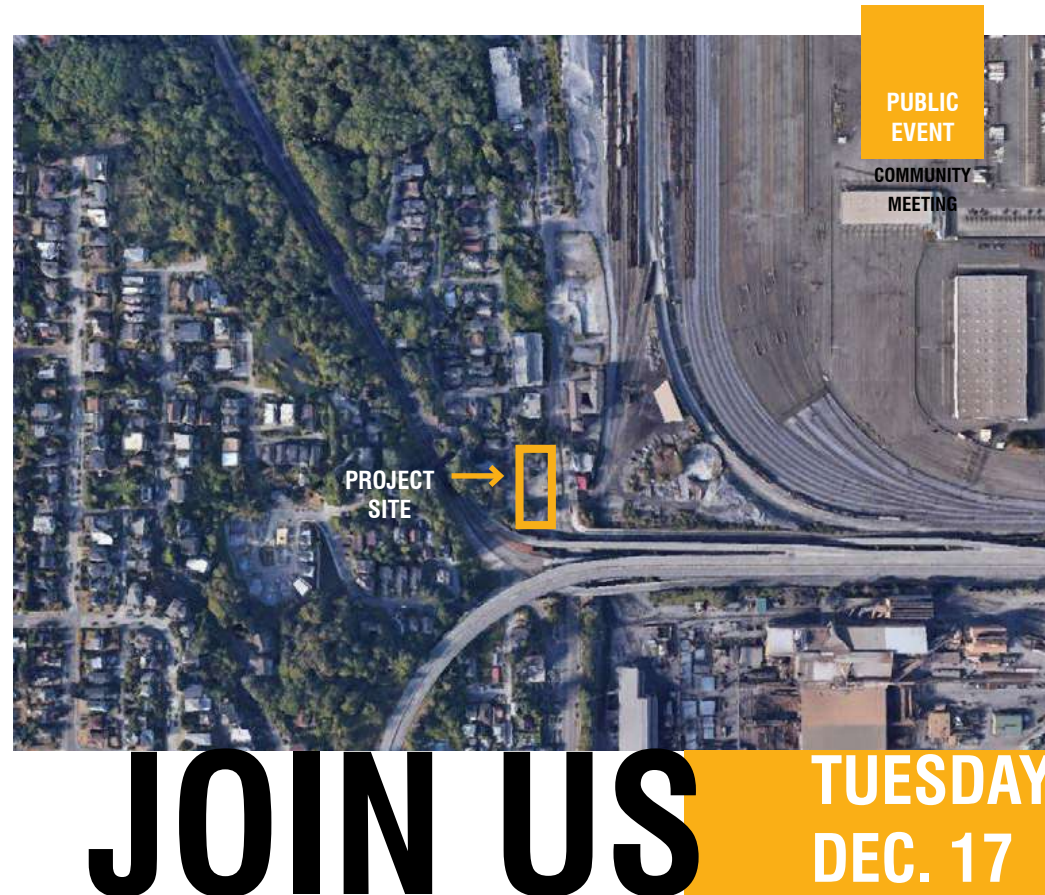

Join us for a community meeting to provide input about the **3417 Harbor Avenue SW Project.**

This project proposes the demolition of an existing building and the construction of a five-story apartment building over a one story parking garage. The project is zoned C1-55.

What: Let us know what you think! Join the project team and their architects to discuss the vision and approach for this new residential project in the neighborhood. Coffee and cookies will be provided. All are welcome. No RSVP needed.

Time: Event begins promptly at 6:30pm and will end around 7:30pm

Date: Tuesday, December 17th, 2019

Where: Hiawatha Community Center, 2700 California Ave SW, Seattle, WA 98116

Project Address:
3417 Harbor Avenue S. Seattle, WA 98126
Contact:
Michelle Linden
Applicant:
Atelier Drome Architecture & Interior Design
Additional Project Information on Seattle Services Portal via Project Address: 3417 Harbor Ave SW
Project Hotline & Email:
(971) 319-3431
communityoutreachad@gmail.com
Note: Calls and emails are subject to City of Seattle public disclosure laws.

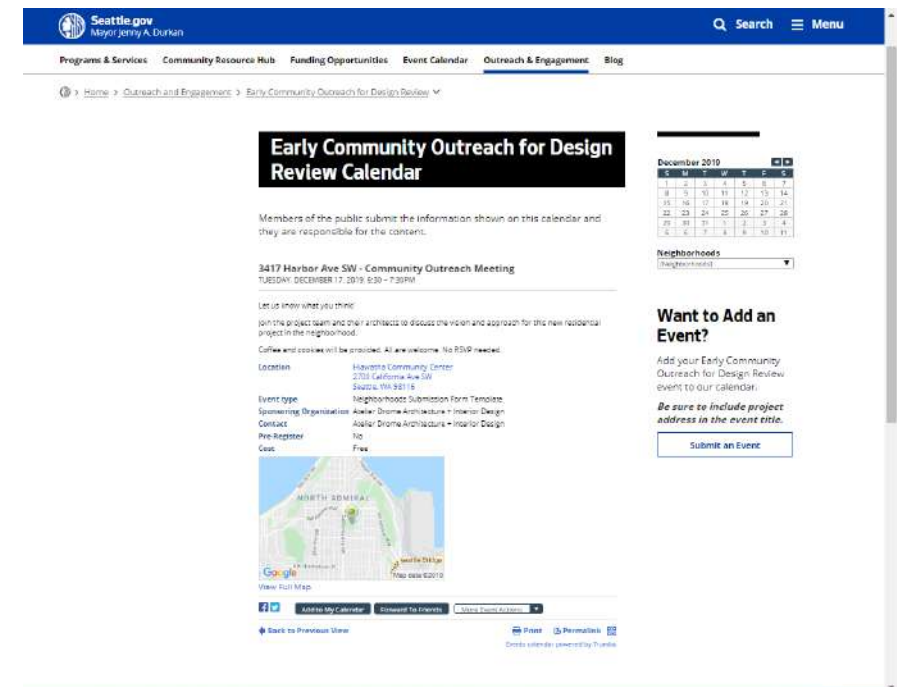

COMMUNITY FEEDBACK

DESIGN RELATED

VIEWS / CONNECTIONS

- The location can be perceived as a gateway site and should establish an architectural style for the neighborhood.
- Some neighbors are concerned about a possible lack of engagement between the proposed building and 30th Ave.
- However, other neighbors are concerned with possible terraces or balconies on this side, citing privacy concerns, and prefer a buffer between the building and 30th Ave.

MATERIALS / DESIGN

- The neighbors voiced a strong preference for the proposed project to have character, suggesting a clean, industrial look. It was also advised that any light-colored materials will be potentially blackened by the nearby trains and traffic.
- No steel siding is requested on 30th Ave; the materials on this facade should reflect the more residential nature of this side.

STREET IMPROVEMENTS

- The neighbors requested no additional street lights be added; likewise, they requested the width of 30th Ave to be maintained.

PARKING / TRAFFIC

- All members of the public present prefer the project to have access off of Harbor Ave.
- Neighbors were concerned that the cars from the proposed project will require street parking that Harbor Ave and 30th Ave does not have capacity for.
- Several neighbors noted that the neighborhood has no light rail stop or any additional transit planned, so residents are required to have a car to navigate to local amenities as the steepness of the neighborhood limits the walkability to places such as grocery stores. This will cause increased traffic onto already congested streets.

TARGET MARKET / PROJECT TYPE

- The neighbors would like the developer to entertain building luxury condominiums or townhouses instead, expressing concern that low / medium income apartments are not appropriate for the neighborhood, as the site serves as a gateway to the more affluent Alki neighborhood.

CONSTRUCTION

- The neighbors expressed concern about how to keep access and roads open to the neighborhood during construction. Neighbors stressed the need to maintain access in the short term without closing lanes or losing street parking spaces.

NON DESIGN-RELATED

MISCELLANEOUS

- A resident of Harbor Condominiums raised the point that the waste collection for her building is currently located on the project site. What will happen to the waste collection location after the proposed project is built? If it is relocated to the garage of Harbor Condominiums as intended, more parking stalls will be eliminated within her building.
- Several neighbors pointed out that the landscaping on the project site is frequently used as a toilet by the dogs in the neighborhood. Where will the dogs go if this landscaping is eliminated? Conversely, if landscaping is being proposed on the project site, neighbors warned about the potential smell, especially during the summer months, that will arise from the pet waste. A trash receptacle with dog waste bags is recommended on 30th Ave
- The neighbors brought up the existing large trees on SPU's lot where 30th Ave and SW Spokane St meet—these trees create a blind spot, which could pose a safety issue for pedestrians crossing from the new sidewalk to the existing sidewalk. They expressed support for these trees to be removed, especially because they are frequently used to hide needles.
- A neighbor opposed the roof deck, stating that roof access on a busy corner lot is not a good idea.
- Several neighbors recommended sound conscious windows, as the area can get very loud.

7.0 ZONING DATA

ZONE	ABUTS	INCENTIVES	RESTRICTIONS	OVERLAY	SITE AREA	USES PERMITTED OUTRIGHT
C1-55(M)	IG2 U/85, SF5000	frequent transit	liquefaction, steep slope, potential slide, landfill	outer transitional surface	15,832sf	residential uses

LAND USE CODE INFORMATION

USES PERMITTED OUTRIGHT

23.47A.004 TABLE A

- residential uses

STREET-LEVEL DEVELOPMENT STANDARDS

23.47A.008

- blank segments of street-facing facades between 2 - 8 feet above the sidewalk may not exceed 20 feet in width. facades with screening or landscaping are not considered blank.
- the total of all blank facade segments may not exceed 40% of the facade width of the structure along the street.
- street-level street-facing facades shall be located within 10 feet of the street lot line unless wider sidewalks, plazas, or other approved landscaped or open spaces are provided
- at least one of the street-level street-facing facades containing a residential use shall have a visually prominent pedestrian entry
- the floor of a dwelling unit located along the street-level street-facing facade shall be at least 4 feet above or 4 feet below sidewalk grade or be set back at least 10 feet from the sidewalk

PARKING LOCATION & ACCESS

23.47A.004 TABLE A

- one garage door is permitted for each curb cut
- when a lot fronts on two or more streets, the Director will determine which of the streets will be considered the front lot line
- parking shall be screened

MAXIMUM STRUCTURE HEIGHT

23.47A.012

- maximum structure height = 55 feet
- certain rooftop features may also extend beyond the height limit (in particular, a stair or elevator penthouse may extend an additional 16 feet), however, some of these features must be located at least 10 feet from the north edge of the roof

MAXIMUM FAR

23.47A.013

- 3.75 on a lot outside of the Station Overlay District
lot area: 15,832 sf
max. FAR: 59,370 sf
- area exempt from FAR: underground stories, portions of a story that extend no more than 4 feet above grade, rooftop greenhouse area

SETBACK REQUIREMENTS

23.47A.014

front (Harbor Ave SW): none

front (30th Ave SW): none

side (north): none (does not abut a residential zone)

side (south): none (does not abut a residential zone)

- a minimum 5 foot landscaped setback may be required under certain conditions and for certain uses per 23.47A.016
- structures permitted in required setbacks: decks, balconies, eaves, cornices, gutters, ramps, fences, underground structures, dumpsters (except trash compactors).

LANDSCAPING & SCREENING STANDARDS

23.47A.016

- a greenfactor score of 0.3 or greater is required (functionally equivalent to landscaping 30% of lot)
**note: credit is awarded for green roofs, planters, green walls, landscaping, and plantings in the adjacent right-of-way*
**note: street trees are required and are counted towards the greenfactor requirement*

REQUIRED AMENITY AREA

23.47A.024

- 5% of the total gross floor area in residential use required (area excludes mech equipment and parking)
- bioretention facilities qualify as amenity areas
- all residents shall have access to at least one common or private amenity area
- amenity areas shall not be enclosed
- no amenity area shall be less than 250sf and shall have a minimum horizontal dim of 10 feet
- private balconies and decks shall have a minimum area of 60sf and no horizontal dimension shall be less than 6 feet

PARKING LOCATION & ACCESS

23.47A.032.B

- within a structure, street-level parking shall be separated from street-level, street-facing facades by another permitted use

REQUIRED PARKING

23.54.015

- residential uses = 1 vehicular space per dwelling unit, 0.5 per SEDU
residential uses = 1 bicycle space per 4 dwelling units
23.54.020.F.2
- minimum parking reduced by 50% if site is located within a frequent transit service area

MANDATORY HOUSING AFFORDABILITY

23.58C.040 TABLE B

- medium area
- zones with a (M) suffix - \$14.46 / sf developer contribution

THIS PAGE INTENTIONALLY LEFT BLANK



stepped massing



activated courtyard



facade patterns



terraced landscape



zone reflective scale



corner residential entry

CS1 NATURAL SYSTEMS

C2 ELEVATION CHANGES

Use the existing site topography when locating structures and open spaces on the site. Consider “stepping up or down” hillsides to accommodate significant changes in elevation.

The site has a significant grade change, sloping down from 30th Ave to Harbor Ave and in the N/S direction along 30th Ave. Taking advantage of the hillside, the building cascades down the hillside in the north/south direction, primarily at the southern portion, to preserve views from the residential homes on 30th Ave and above. Along 30th Ave, the building is carved out to reduce the massing facing the residential zone. This also provides open spaces and allows daylight at each residential unit, with at-grade connections to the landscape.

D1 ON-SITE FEATURES

Incorporate on-site natural habitats and landscape elements such as: existing trees, native plants species or other vegetation into project design and connect those features to existing networks of open spaces and natural habitats wherever possible. Consider relocating significant trees and vegetation if retention is not feasible.

The preferred scheme creates a landscaped courtyard that descends down the hillside and speaks to the adjacent residential neighborhood character. Terraced areas are planted with native landscape with bright pops of color that change seasonally, for year-round interest. The preferred scheme relocates existing healthy trees and provides equivalent tree replacement for sick and hazardous trees. The landscape incorporates built elements such as benches and steps in order to activate the courtyard and to help provide a physical and visual connection to the residents on 30th Ave. At Harbor Ave, ground and vertical greenscape provides texture, seasonal interest, and garage screening.

DC2 ARCHITECTURAL CONCEPT

B1 FACADE COMPOSITION

Design all building facades - including alleys and visible roofs - considering the composition and architectural expression of the building as a whole. Ensure that all facades are attractive and well-proportioned through the placement and detailing of all elements, including bays, fenestration, and materials, and any patterns created by their arrangement. On sites that abut an alley, design the alley facade and its connection to the street carefully. At a minimum, consider wrapping the treatment of the street-facing facade around the alley corner of the building.

The building facade will be developed intentionally, with awareness to material texture, patterning, and fenestration. The scale of the building will be studied, with special attention to the street frontage and the interaction with the residential neighborhood along 30th Ave. The project started this process with the design of the visible roofs - carefully considering placement of amenity spaces and planted areas and their relationship to the neighboring residential views - and in the conceptual analysis of materials, to create a design that provides additional detail, depth, and scale that is secondary to the overall design.

CS2 URBAN PATTERN & FORM

A1 SENSE OF PLACE

Emphasize attributes that give Seattle, the neighborhood, and/or the site its distinctive sense of place. Design the building and open spaces to enhance areas where a strong identity already exists, and create a sense of place where the physical context is less established. Examples of neighborhood and/or site features that contributed to a sense of place include patterns of streets or blocks, slopes, sites with prominent visibility, relationships to bodies of water or significant trees, natural areas, open spaces, iconic buildings or transportation junctions, and land seen as a gateway to the community.

At the edge of North Admiral and Alki, the preferred scheme ties in to the local fabric and speaks to the neighborhood identity, through its main corner entry, response to zoning changes, and relationship to the streets. The strong street edge along Harbor Ave is maintained, while the massing is broken up along 30th Ave to relate to the residential zone

The building’s corner establishes a gateway to the neighborhood, with the building’s main residential entry at the street-level. Additionally, the scheme responds directly to the two abutting zones – providing a strong form fronting the busy transit-oriented Harbor Ave and a more modulated, pedestrian scale form along 30th Ave. The residential neighborhood to the west feels tucked into the hillside and woods, and the landscaped courtyard will reflect the character of the neighborhood. The frontage along Harbor Ave SW responds directly to the typical typology of apartment buildings built in the area, with an orthogonal form above a plinth-like base with a garage entry.



neighborhood typology



residential scale massing



secondary facade elements



identify entry



integral bench

CS2 URBAN PATTERN & FORM

D3 ZONE TRANSITIONS

For projects located at the edge of different zones, provide an appropriate transition or complement to the adjacent zone(s). Projects should create a step in perceived height, bulk and scale between anticipated development potential of the adjacent zone and the proposed development. Factors to consider:

- a. distance to the edge of a less (or more) intensive zone;
- b. differences in development standards between abutting zones;
- c. the type of separation from adjacent properties (e.g. separation by property line only, by an alley or street or open space, or by physical features such as grade change);
- d. adjacencies to different neighborhoods or districts; adjacencies to parks, open spaces, significant buildings or view corridors; and
- e. shading to or from neighboring properties.

This project shifts the weight of the massing towards the more intensive industrial zone to the east and away from the less intensive residential zone to the west. The stepped massing on the southern edge also helps provide more opportunities for views and open air. The steeply sloping grade and distance between the edge of sidewalk and the edge of the building creates a large open space adjacent to the single family zone, providing a visual connection while maintaining privacy.

A large roof deck is proposed which will allow residents to take advantage of the spectacular views of downtown Seattle and the Duwamish Waterway. These areas will allow for social interaction, barbecues, etc. There is a landscaped area proposed on the hill at the western side of the building, which will provide areas to connect directly with nature and encourage physical activity.

PL3 STREET-LEVEL INTERACTION

A1 ENTRIES: COMMON ENTRIES TO MULTI-STORY RESIDENTIAL BUILDINGS

Need to provide privacy and security for residents but also be welcoming and identifiable to visitors. Design features emphasizing the entry as a semi-private space are recommended and may be accomplished through signage, low walls and/or landscaping, a recessed entry area, and other detailing that signals a break from the public sidewalk.

In the preferred scheme, the building entry is easily identifiable and welcoming to residents and visitors, through color, material change, or a change in massing.

PL4 ACTIVE TRANSPORTATION

C2 ON-SITE TRANSIT STOPS

If a transit stop is located on-site, design project-related pedestrian improvements and amenities so that they complement (or at least do not conflict with) any amenities provided for transit riders. Consider the proximity of transit queuing and waiting areas to other pedestrian gathering spaces, aiming for enough room to accommodate all users. Similarly, keep lines of sign to approaching buses or trains open and make it clear through location and design whether project-related pedestrian lighting, weather protection, and/or seating is intended to be shared by transit users.

Currently there is an existing transit stop located near the site marked only by a sign. Shifting the vehicular access to the opposite corner of the site increases the separation between pedestrians and vehicles. The public realm will be further developed by providing integrated seating, located close to the main building entry for full visibility and safety.

DC2 ARCHITECTURAL CONCEPT

E1 LEGIBILITY & FLEXIBILITY

Strive for a balance between building legibility and flexibility. Design buildings such that their primary functions and uses can be readily determined from the exterior, making the building easy to access and understand. At the same time, design flexibility into the building so that it may remain useful over time even as specific programmatic needs evolve.

The typology of the building is readily apparent and consistent with the typology of structures all along Harbor Ave SW. The clearly defined base of the building containing the parking and access points supports the apartments above, making the building easy to access and understand. The apartments are laid out with regularity, so that they could be modified or combined in the future if the need arises.



rooftop deck

SITE CONSIDERATIONS

The existing site conditions present a few challenges that must be considered by any design scheme and inform the massing of all.

STEEP SLOPE

The site's slope is the most important factor shaping the design. The site slopes in two directions - both north to south and east to west. Each direction impacts the mass.

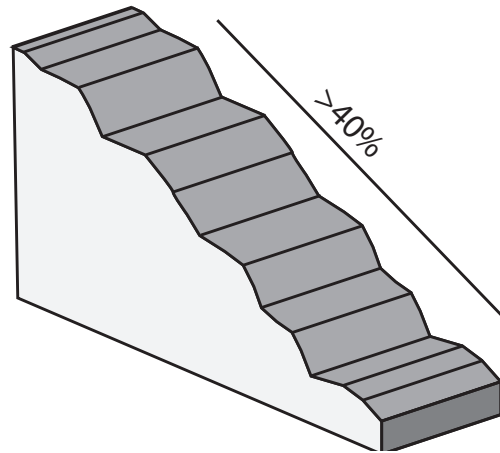

POWERLINES

The high-voltage power lines running along 30th Ave require a 14' offset from any proposed structure.

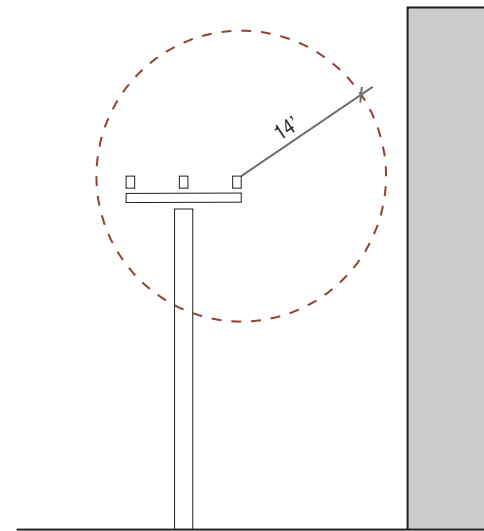

SETBACK CONSIDERATIONS

Although no setbacks are required, pushing back the building at all sides benefits the project:

- better accommodate the existing topography
- allow more light & air for future residents
- creates more separation & views
- accommodates required structural shoring dictated by site topography

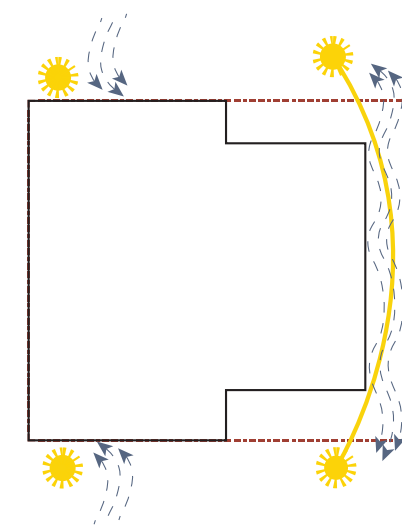

SHORING

There are many options for temporary and permanent shoring to work with the existing slope. However, each method comes with physical limitations and code restrictions.

Tiebacks are planned for this project, but the overall height of the proposed cut/fill and shoring is limited by the length of tiebacks and the width of the street. This has contributed to pushing the building edge away from the 30th Ave property line.

It is infeasible to extend shoring tiebacks into private property where they could conflict with existing foundations and basements.

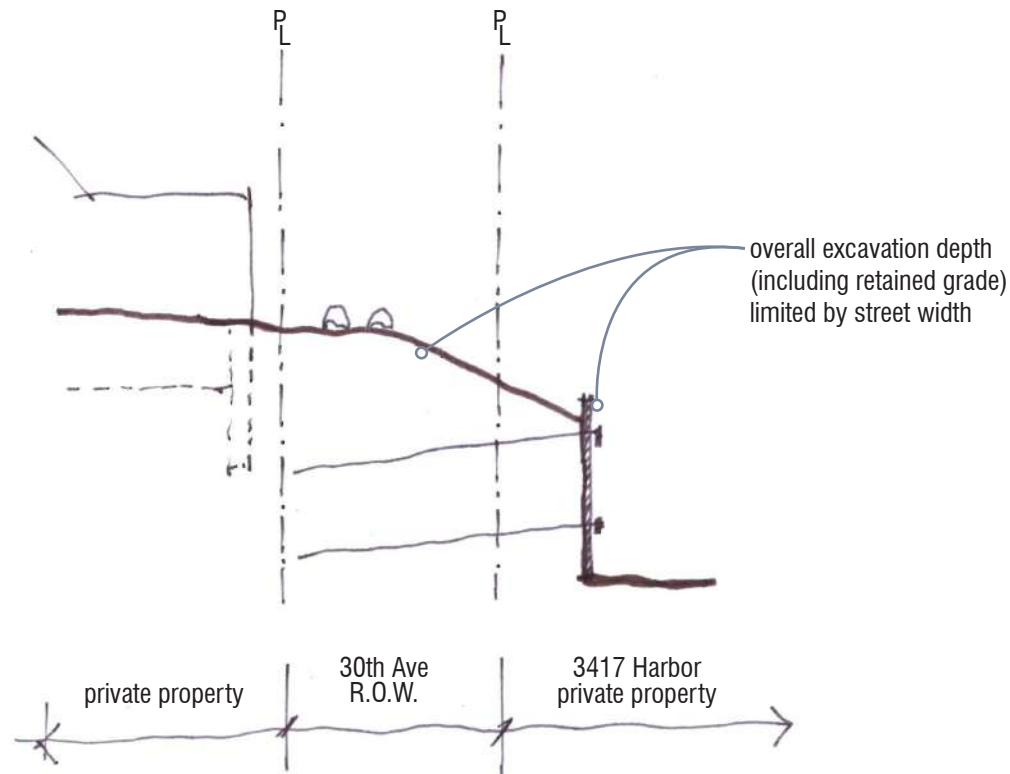

SETBACKS & ACCESS

Taking vehicular access from either street is allowed per code and each option was considered. With the existing height difference between Harbor Ave and 30th Ave, access from 30th Ave would put a garage in the middle of a residential building (an odd and unpleasant design condition) and accessed by a vehicular bridge (a system not allowed by SDOT). More importantly, the neighbors are concerned that this condition would increase traffic, light, glare, and noise along a quiet residential street.

With parking accessed off Harbor Ave, the garage will be held tight to Harbor Ave in order to minimize the required excavation for shoring.

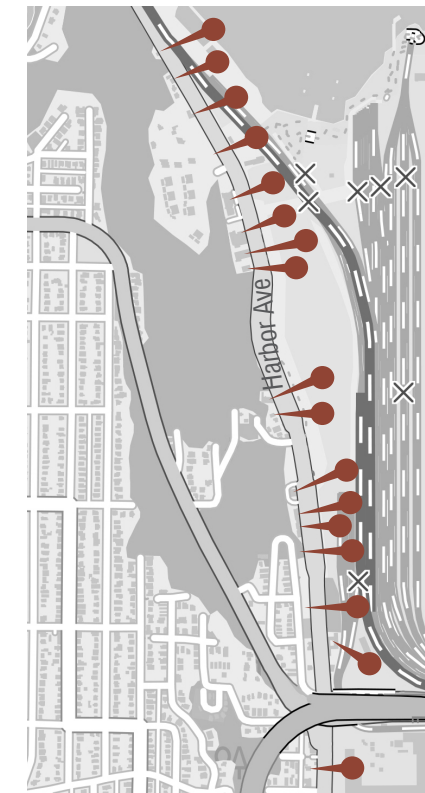

existing vehicular access for buildings along Harbor Ave

SITING CONSIDERATIONS

Careful examination of where the building would sit on the site was another important step in the design process.

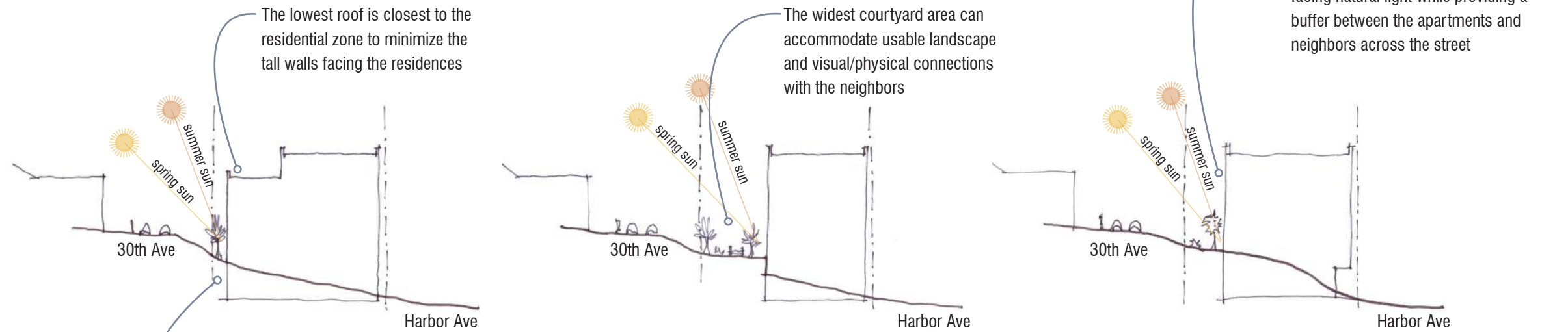

LANDSCAPED OPEN AREAS

The landscaped open areas between 30th Ave and the building transform as the building massing shifts, creating opportunities for the landscaping to weave in and out. The landscape adapts to the space provided, presenting a variety of plantings, hardscape, and seating. It also provides possibilities for visual and physical connections to 30th Ave while still providing a buffer between the larger apartment building and the residential zone.

Due to the steep slope, a 5' minimum planting strip is required on the property for street trees

SEPARATION OF ACCESS

There is an existing bus stop adjacent to the project site on Harbor Ave. Reuse of the site's existing curb cut would put the building's vehicular access close to the bus stop and lead to potential safety issues. The design proposes to move the curb cut farther north to reduce potential conflicts.

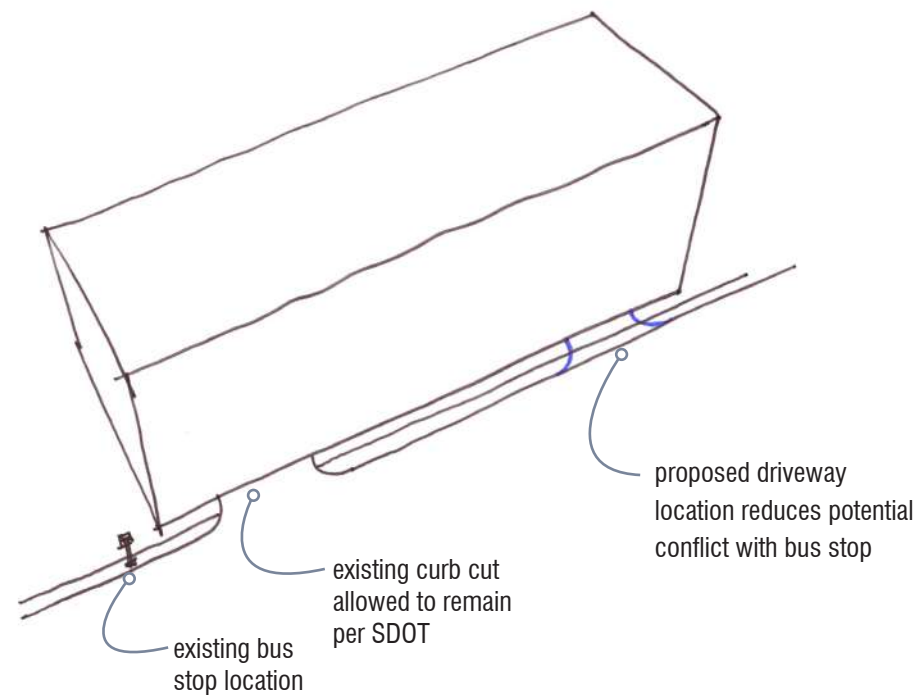

ZONE TRANSITION

To the west of the site are single family homes. The building could take advantage of the natural site slope by stepping down the massing towards Harbor Ave and the water and City views. Instead, the building's massing is weighted towards Harbor Ave to be respectful of the single family homes and prevent a looming facade on 30th Ave.

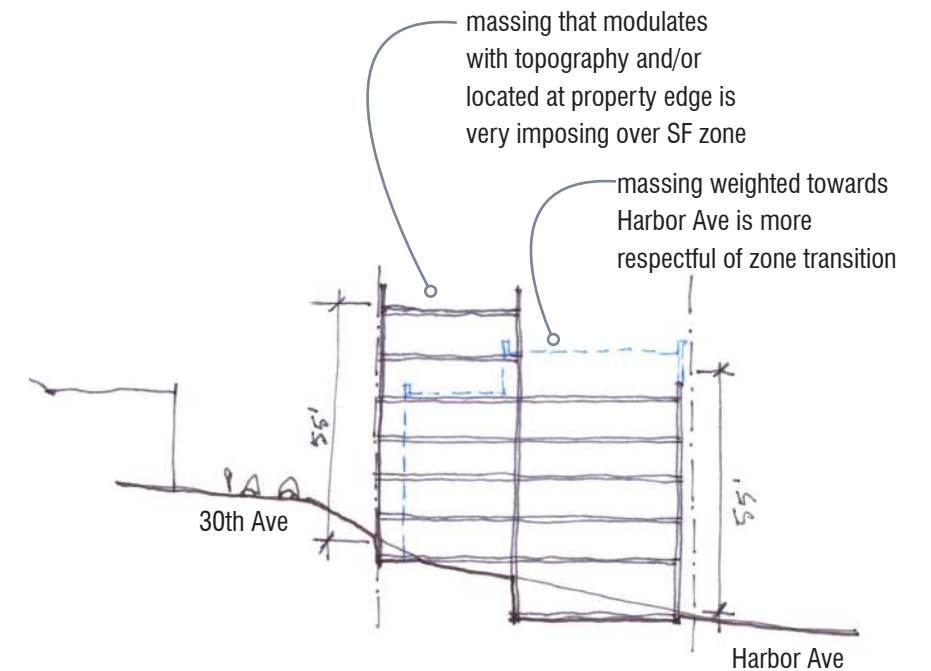

EXISTING DESIGN THEMES

Many of the existing buildings, of all scales, share a simple proportion strategy of 1/3 : 2/3. This creates a solid plinth base and an expressive top. This same 1/3 : 2/3 proportion can similarly be seen in the vertical divisions.

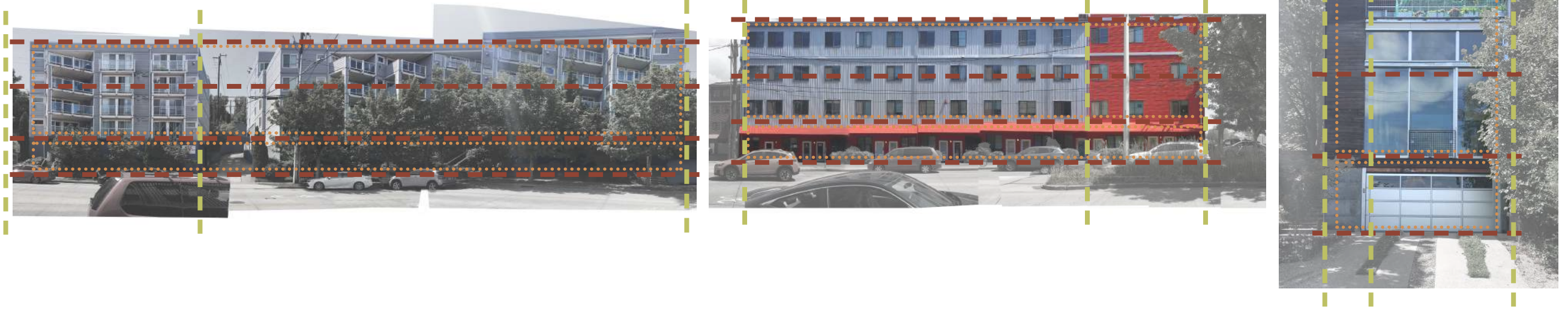

ADDITIONAL DESIGN CONSIDERATIONS

- modulation
- massing
- transition between scales
- transition between materials



material changes to accentuate modulation



secondary architectural features



clean rhythms with simple massing



voids to break down massing

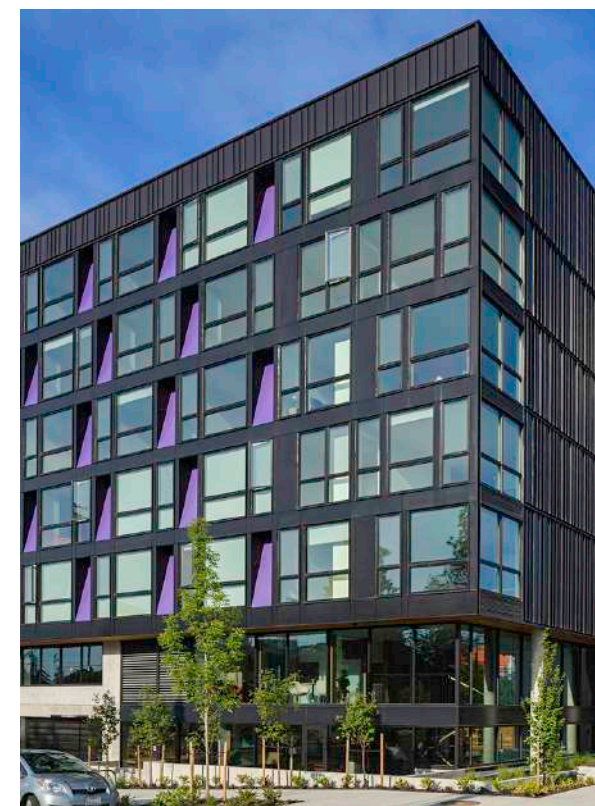

simple materials with bright accents

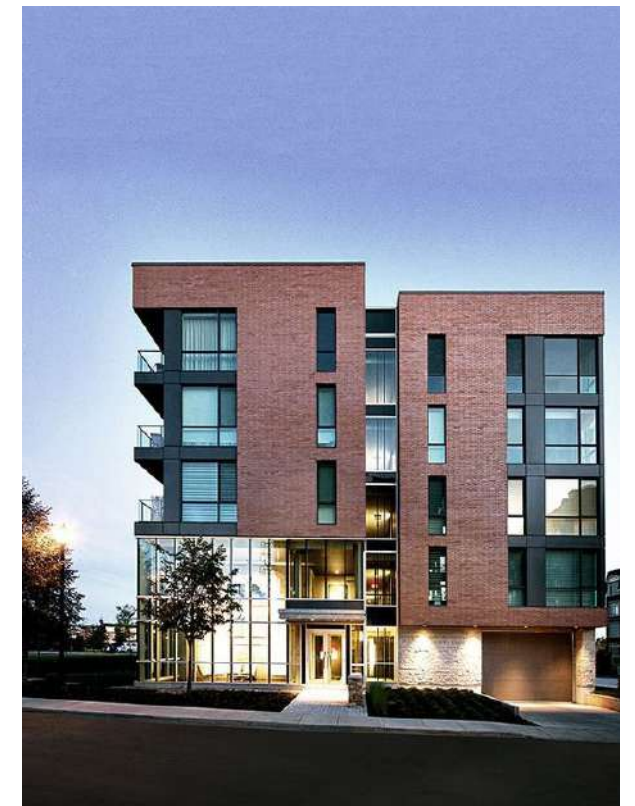

clean rhythm with clear moves

MASSING COMPARISONS

Responding to the differences in surrounding building scale, the massing schemes seek to take advantage of the site's natural slope. The schemes study ways to push the building form towards the larger scale commercial edge of Harbor Ave and pull away from the smaller scale residential edge of 30th Ave.

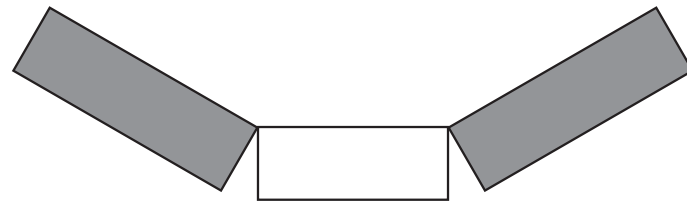

scheme 1

HINGE (CODE COMPLIANT)

Folding the edges of the building reduces the sense of mass and frames a courtyard facing 30th Ave.

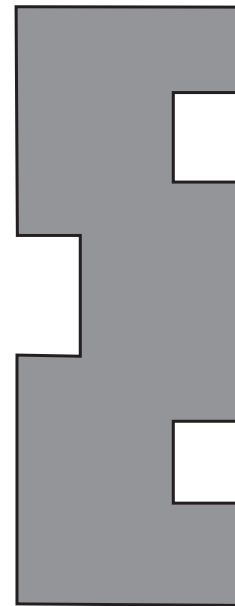

scheme 2

DADO

Pushing and pulling the building mass creates a rhythm to the modulation and pockets of landscaping opportunities.

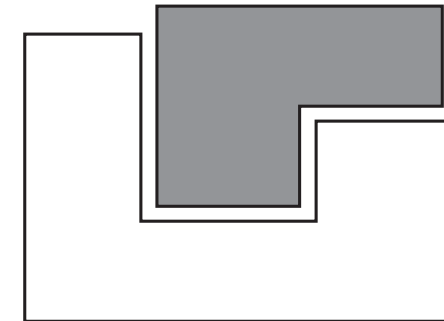

scheme 3

INTERLOCK (PREFERRED)

Subtracting a large void from the building mass condenses the landscape into a central courtyard.

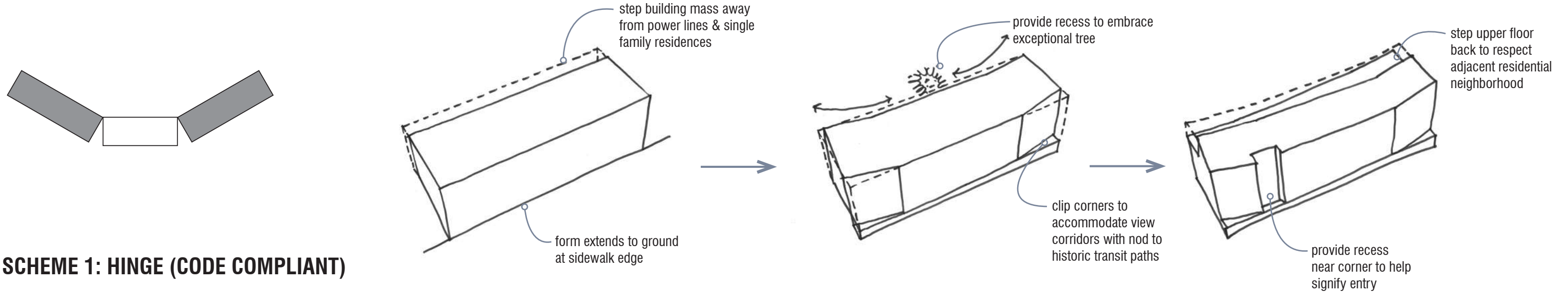

SCHEME 1: HINGE (CODE COMPLIANT)

Scheme 1 is a zoning compliant scheme that primarily maintains the hard line building frontage along Harbor Ave, with the hinge points providing clipped corners for relief in the mass. Along 30th Ave, the building embraces the existing exceptional tree and accommodates a landscaped courtyard facing the residential zone. The building mass steps back from the residential zone in order to provide additional relief. The lobby is located at the southeast corner of the building, with the garage access at the northeast corner.

NO. OF UNITS: 134 apartments
 PARKING: 42 stalls

BENEFITS:

- provide bulk of massing along eastern edge fronting the commercial/industrial zone
- steps building away from residential zone

CONCERNS:

- massing does not step with the grade
- a blank hallway faces the residential zone at the upper level
- little to no variation and modulation along length of building, particularly fronting 30th Ave
- no relief at Harbor Ave streetscape
- significantly reduced parking

POTENTIAL DEPARTURES:

- none

COMMUNITY OUTREACH INTEGRATION:

- upper floor is facing Harbor Ave, instead of looming over 30th Ave, for increased privacy for neighbors
- provide dog waste receptacles along 30th Ave

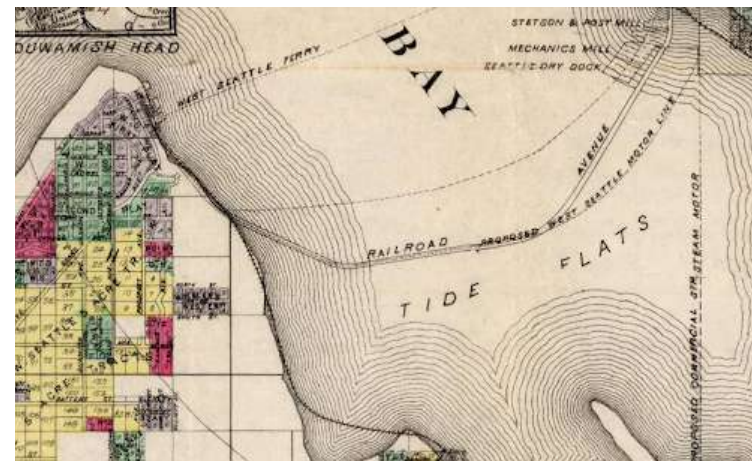

CONCEPT

The project site was historically near an industrial center, and it became a prime location for sawmills, shipyards, brickyards, steel works, and canneries because of its accessibility to Seattle by rail and ferry

This concept speaks to the hinge point of these connection pathways, from the historic ferry terminal to the north, the Railroad Avenue line that ran across the bay, and to the wooden plank roads connecting to Youngstown

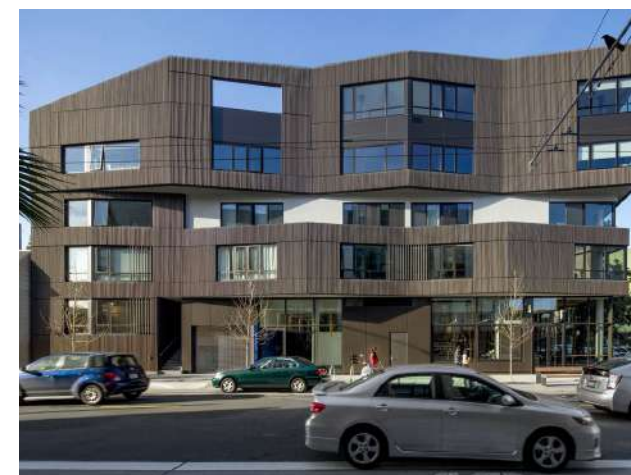

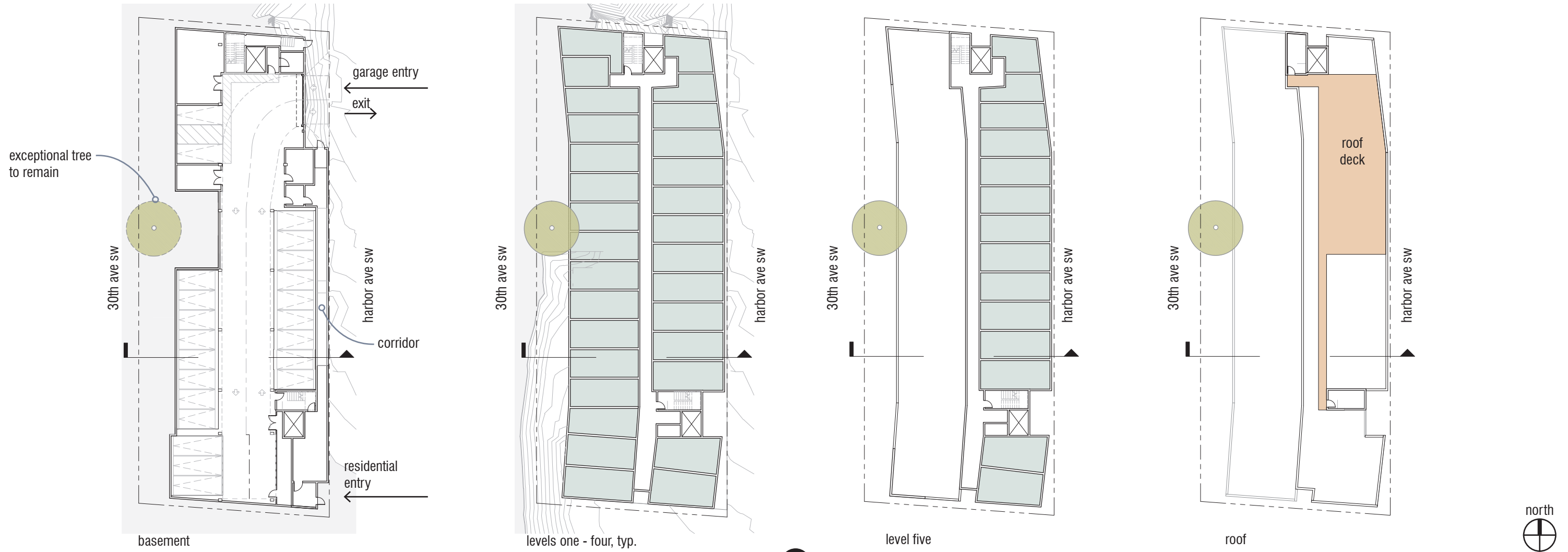

- 1 Stepped massing respects zone transition - CS2.D.3
- 2 Mass set back from property line respects adjacent sites - CS2.D.5

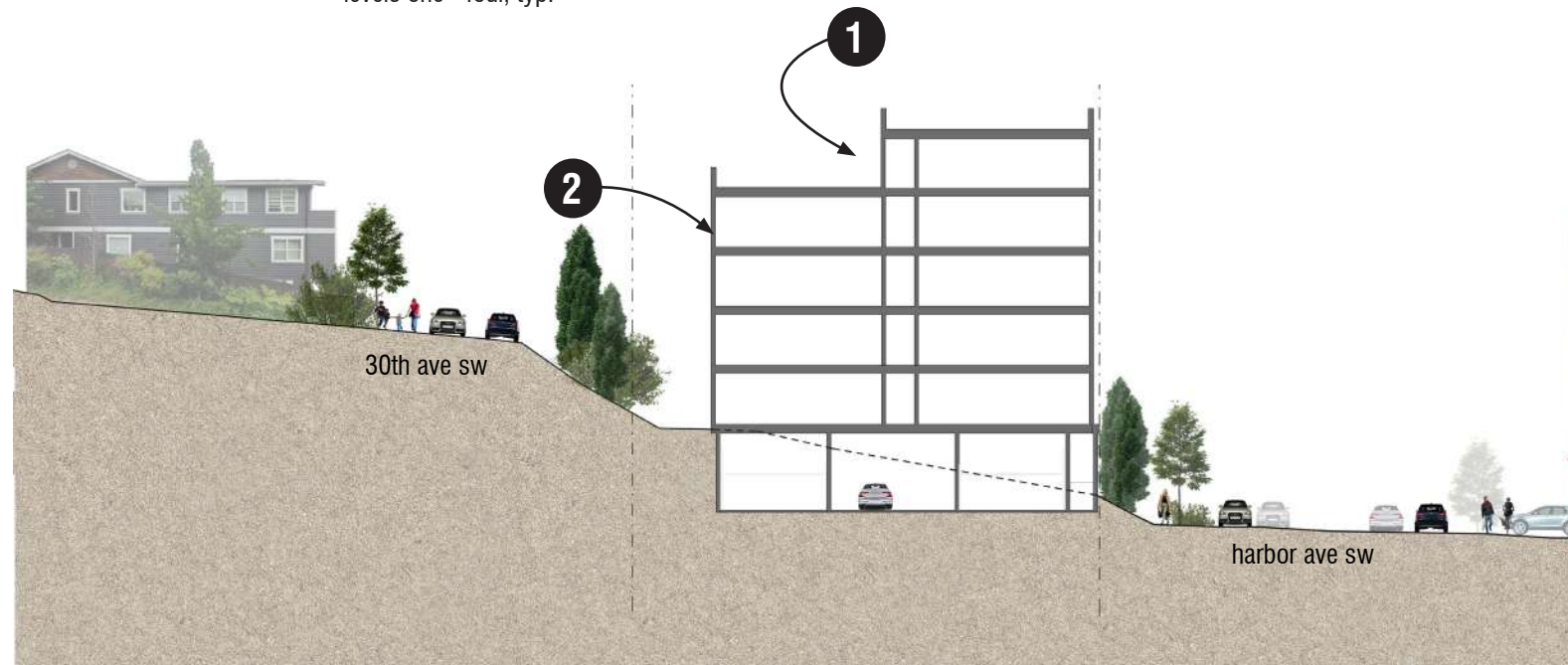

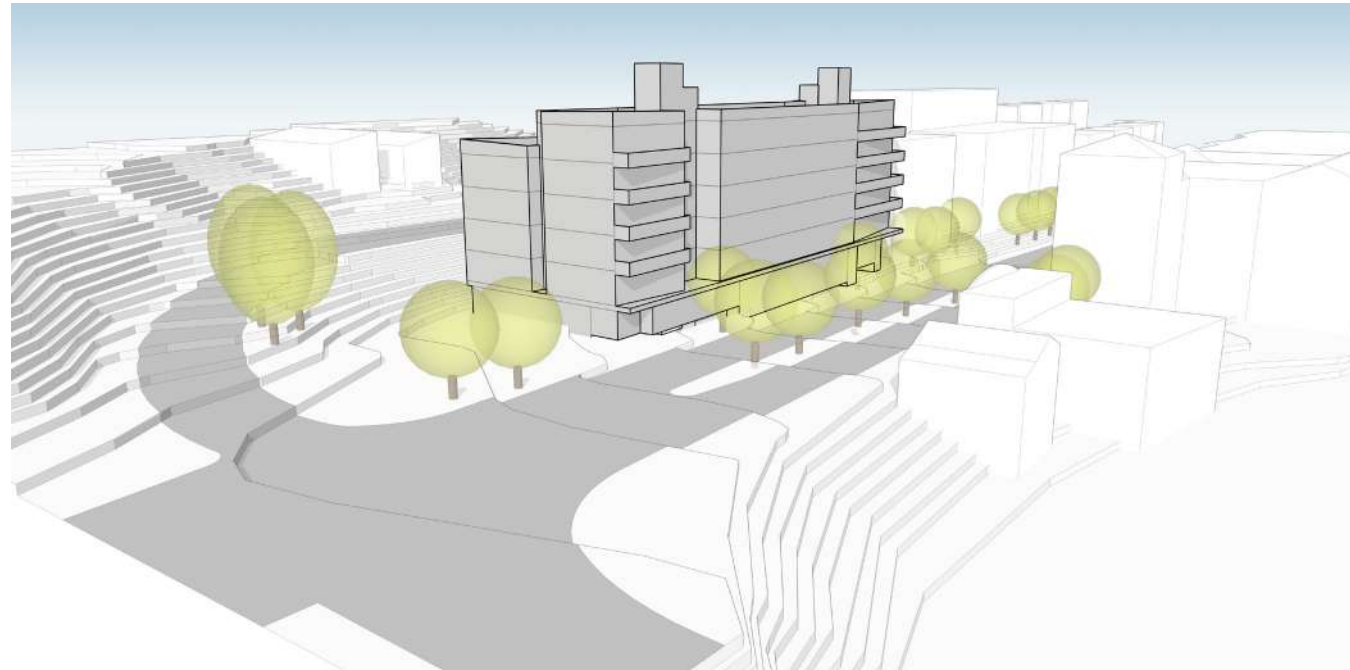

aerial view from West Seattle Bridge



aerial view north along 30th Ave

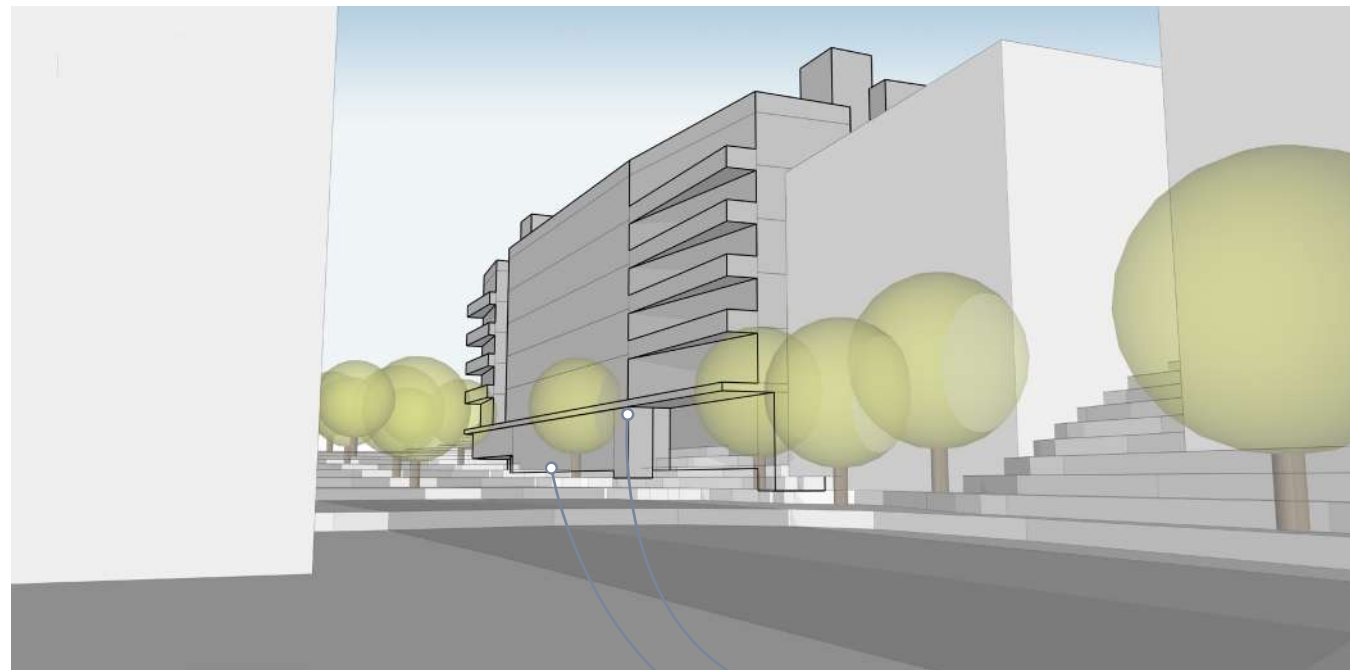

view of north corner from Harbor Ave

maintains hard edge at commercial zone
no opportunity for planting between sidewalk and building edge

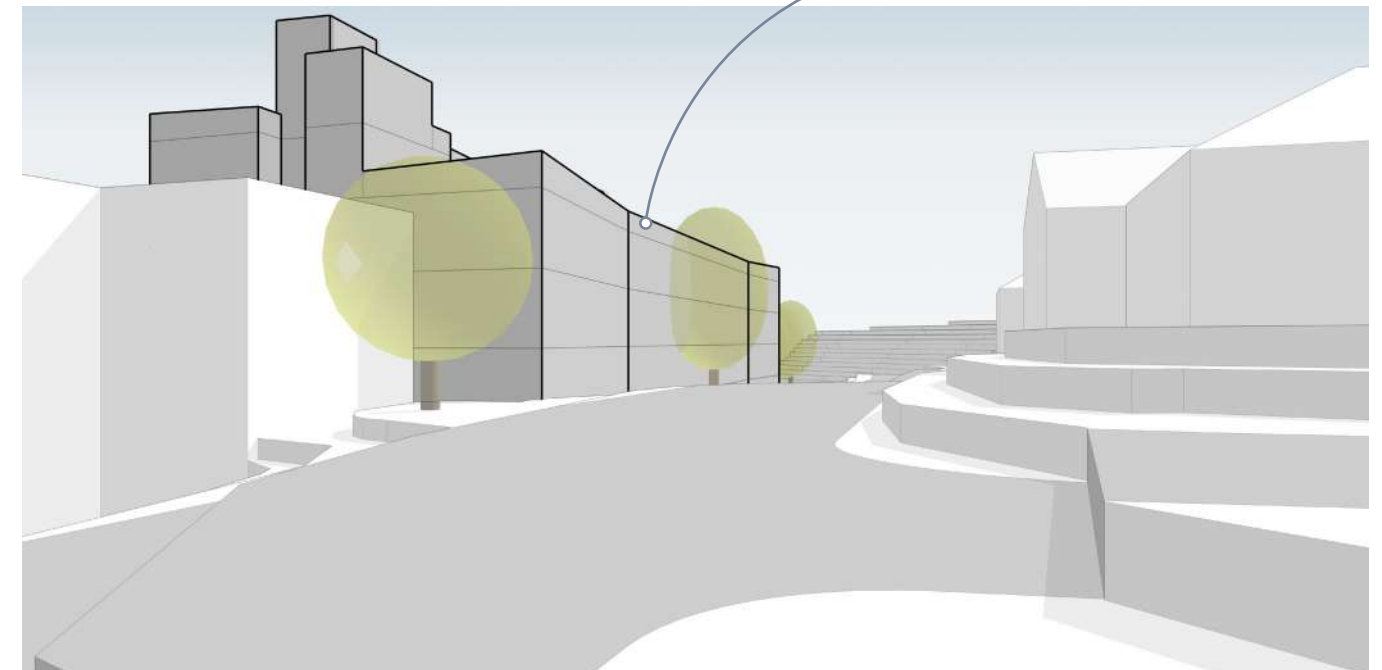

view from 30th looking south towards West Seattle Bridge

reduced bulk fronting residential zone



JUNE 21

9AM

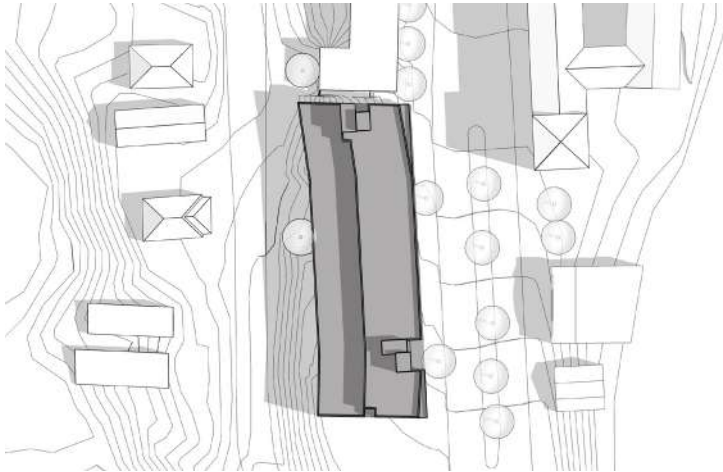

12PM

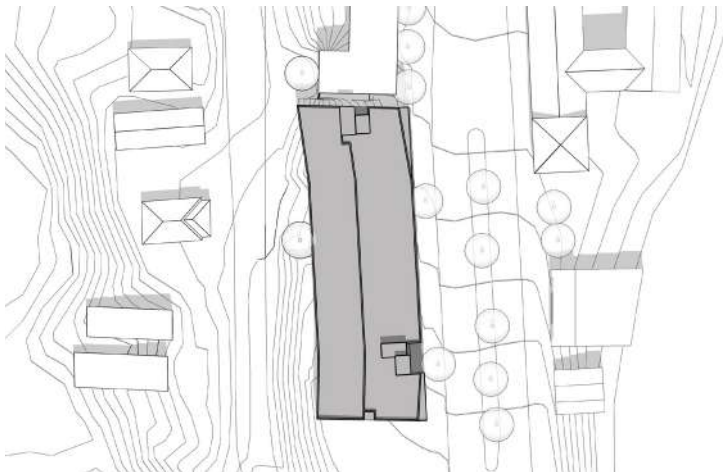

3PM

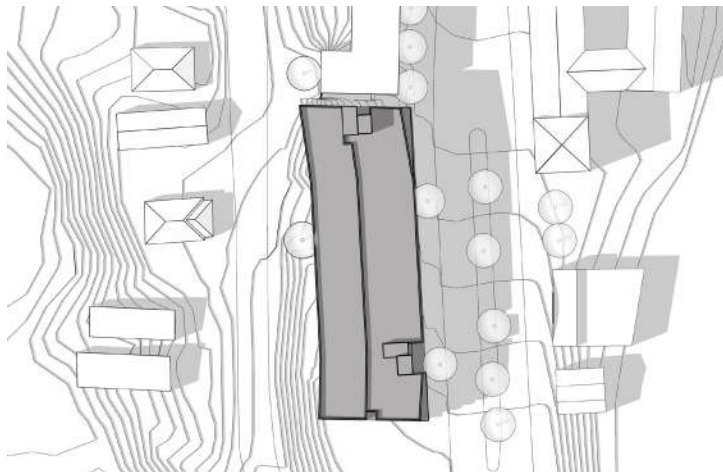

MARCH/SEPTEMBER 21

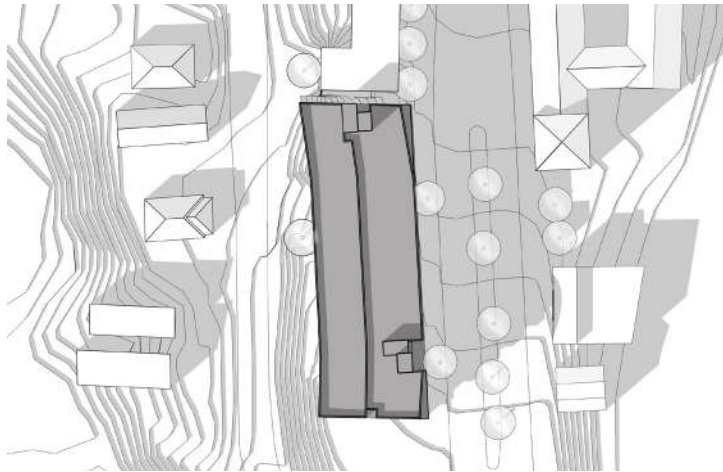
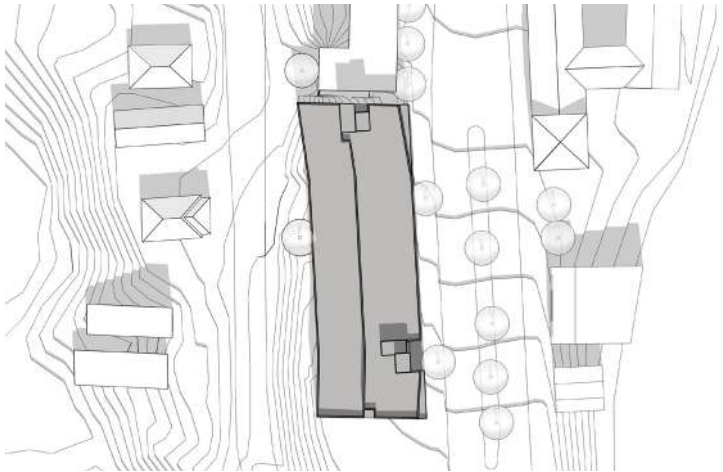
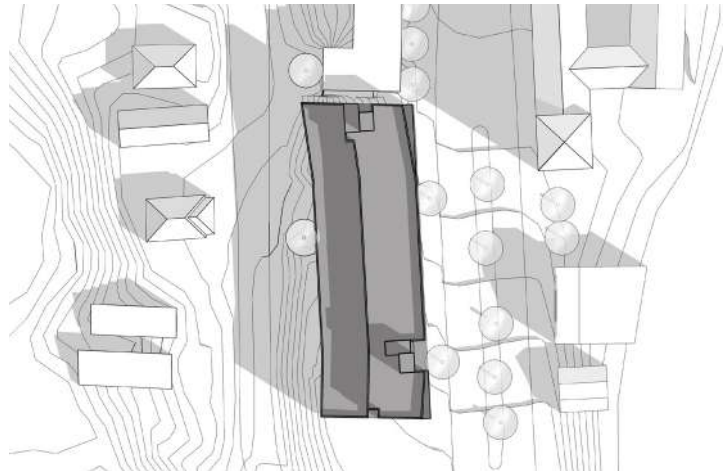

DECEMBER 21

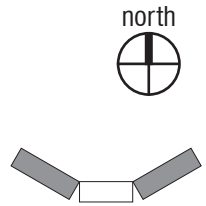
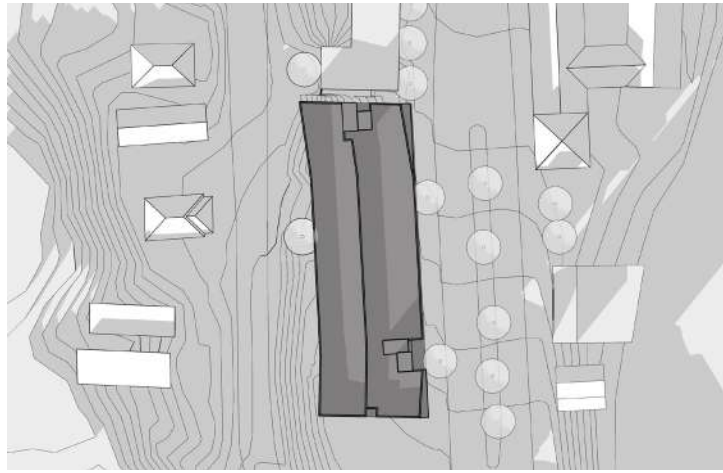
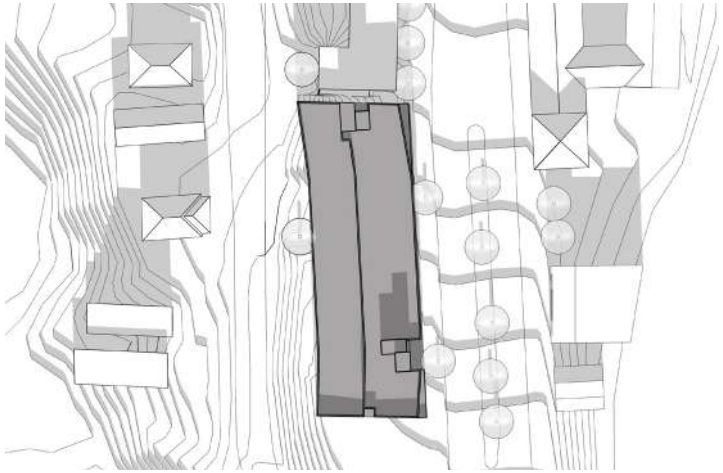
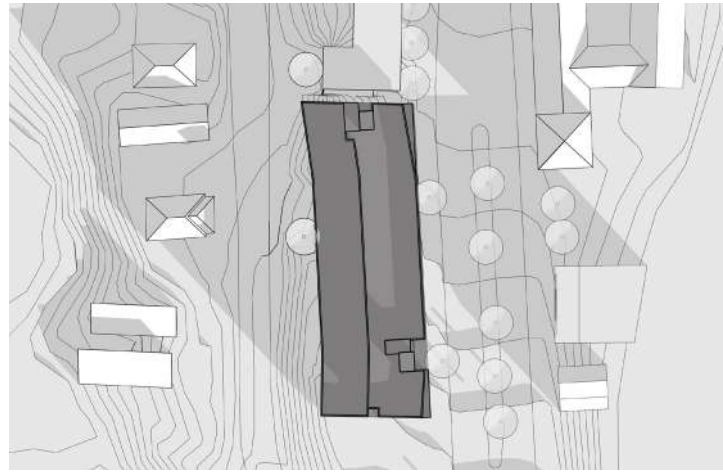

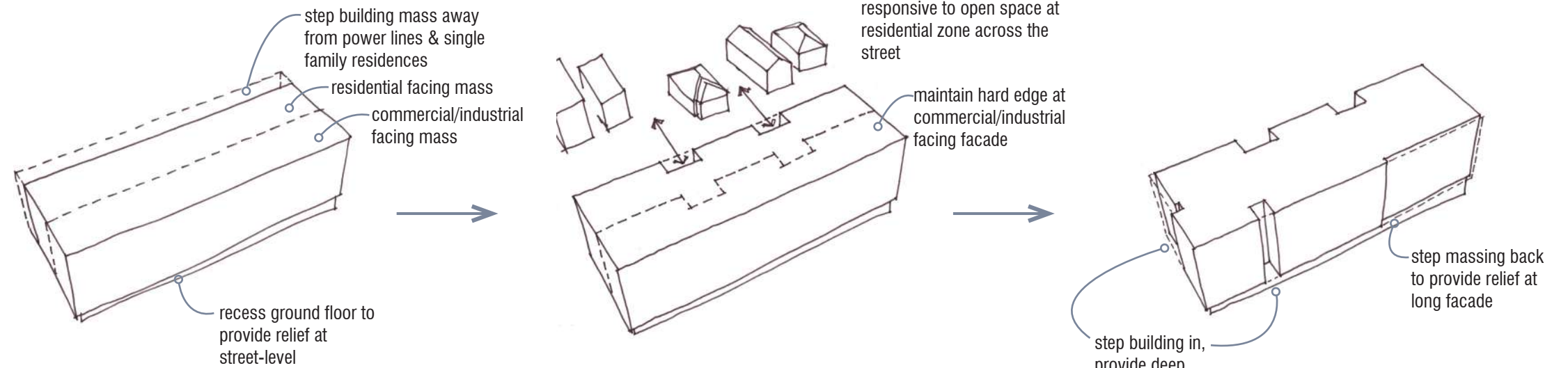
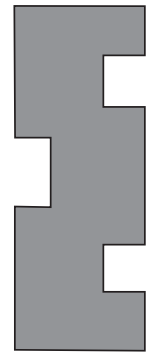

Scheme 2: DADO

Scheme 2 maximizes the building's frontage along Harbor Ave, and modulates the massing to respond to the residential neighbors along 30th Ave. The lobby is located at the southeastern corner of the building with the garage access off of Harbor Ave on the northeastern end of the site.

NO. OF UNITS: 140 apartments
 PARKING: 68 stalls

- BENEFITS:**
- maximizes light and views to the east.
 - provides a modulated massing facing the residential zone.

- CONCERNS:**
- little to no variation and modulation along the Harbor Ave facade.
 - height and bulk of the building is maintained on the residential side and zone
 - windows within interior courtyards facing north and south will receive little direct light due to narrow width

- POTENTIAL DEPARTURES:**
- exceptional tree
 - street-level parking

- COMMUNITY OUTREACH INTEGRATION:**
- provide dog waste receptacles along 30th Ave
 - increased parking over code compliant scheme (42 parking stalls in the "hinge" scheme)

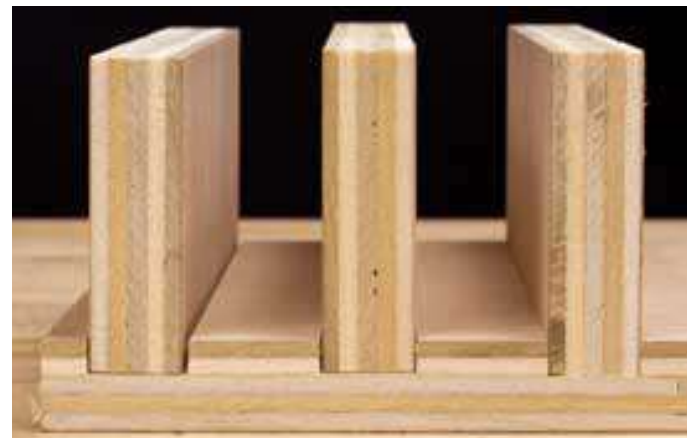

CONCEPT

By inserting smaller scale residential elements into a larger scale commercial element, a rigid connection is created between. The joining of the two elements strengthens the relationship between the zones, an important factor in an area with distinct zone changes.



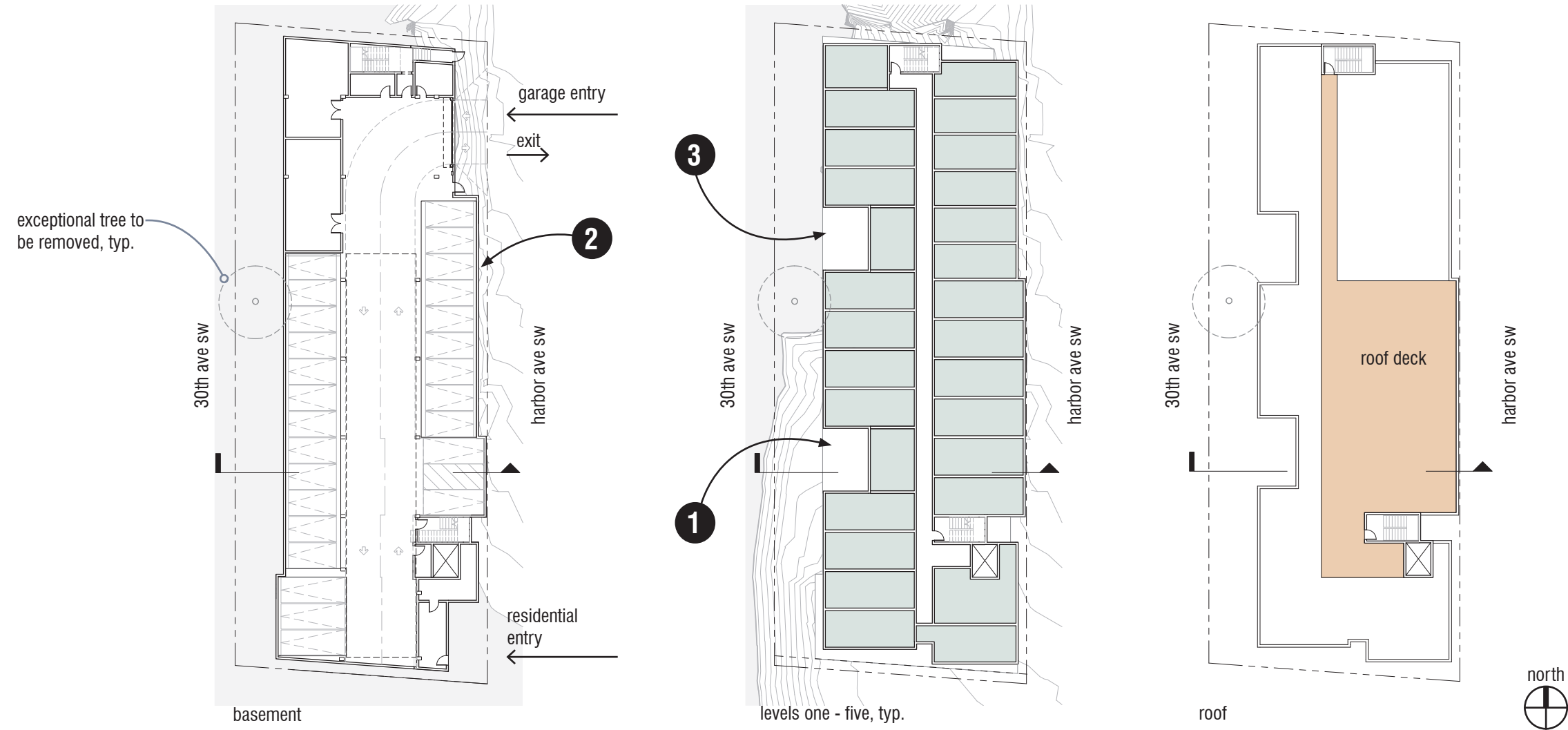

- 1 Massing choices include recesses along the residential facing mass - CS2.D.4
- 2 Recessing the ground floor at street edge allows for greater connection to street with landscape strip, seating, etc. - CS2.B.2
- 3 Landscape takes advantage of natural character of site to provide multiple open space opportunities - DC3.B.4

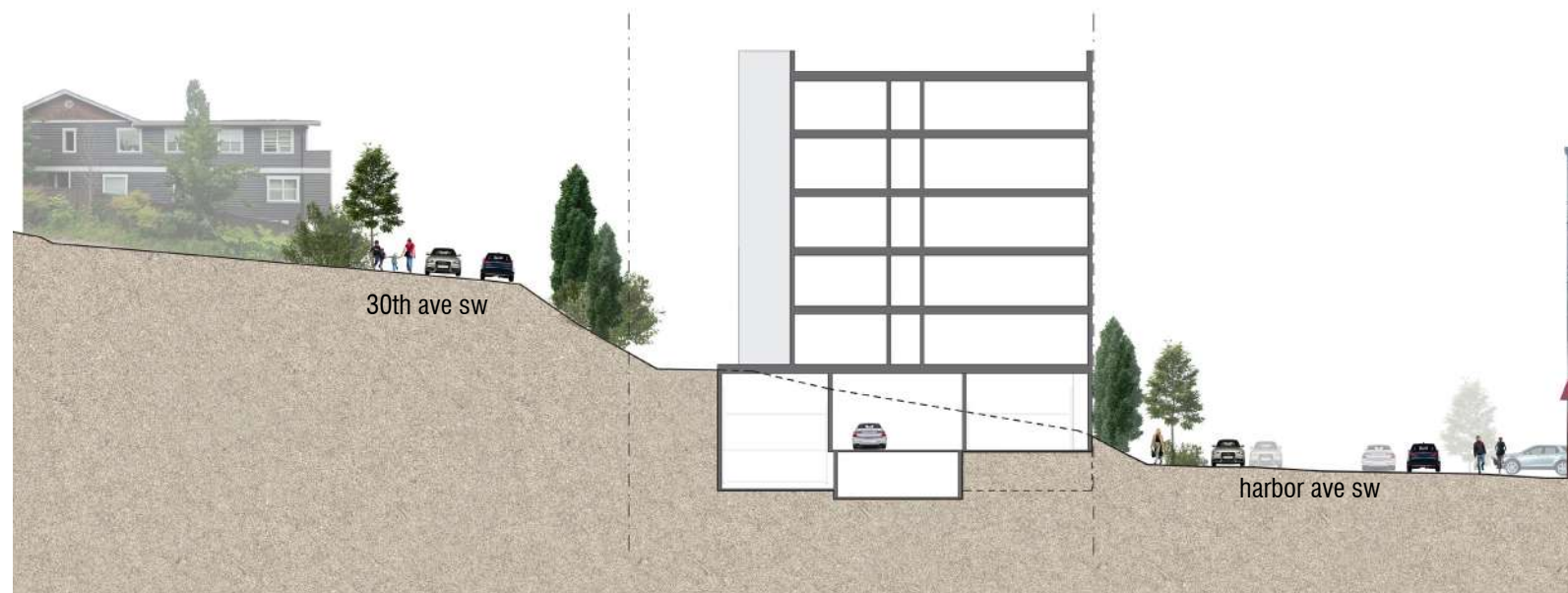



aerial view from West Seattle Bridge

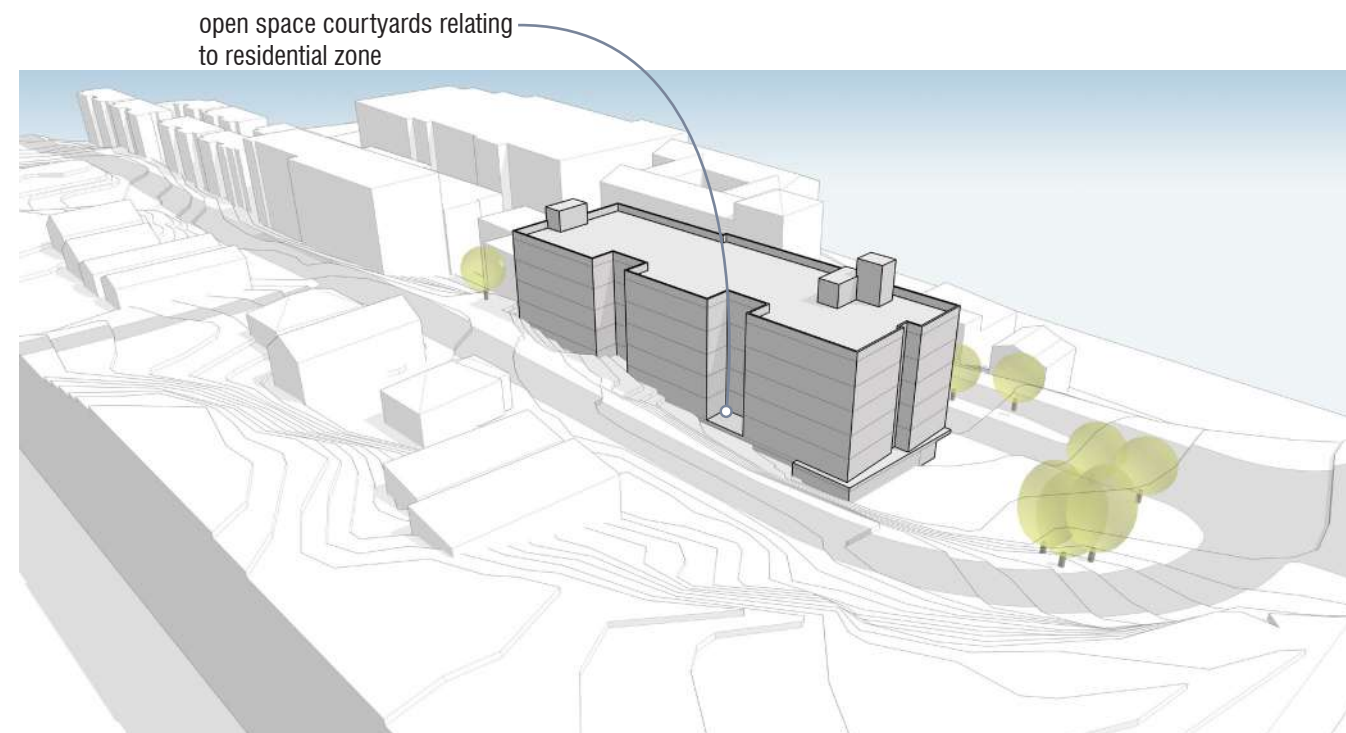

aerial view north along 30th Ave

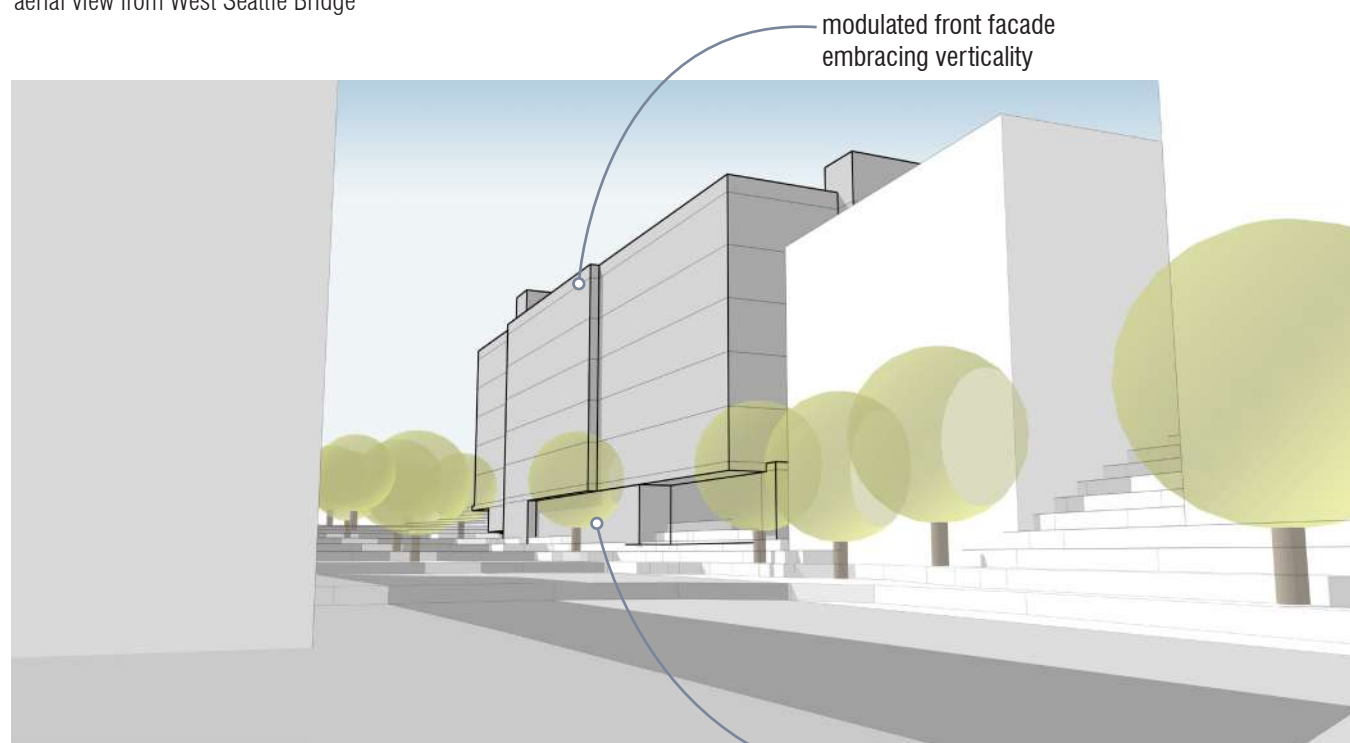

view of north corner from Harbor Ave

modulated front facade embracing verticality

street-level parking departure allows building to be set back from property line and provides space for planting and other public elements

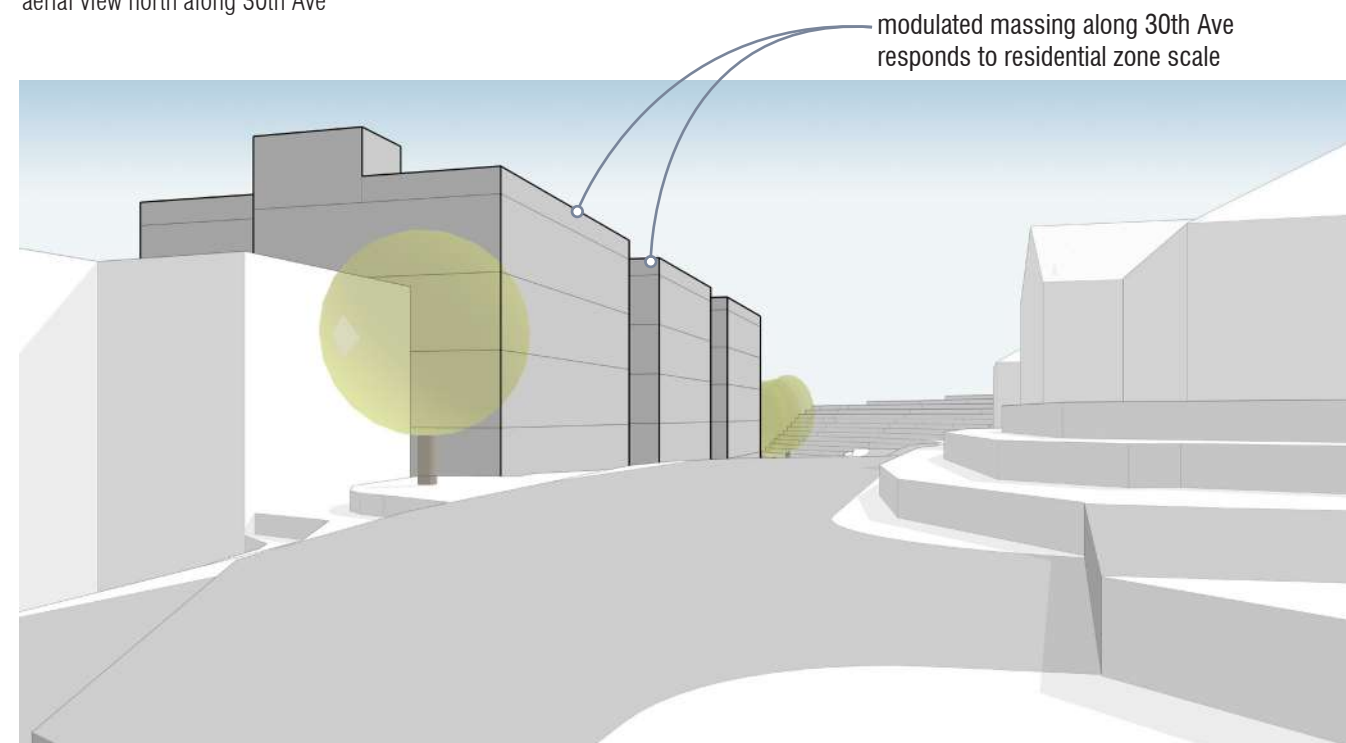

view from 30th looking south towards West Seattle Bridge

modulated massing along 30th Ave responds to residential zone scale

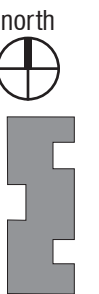
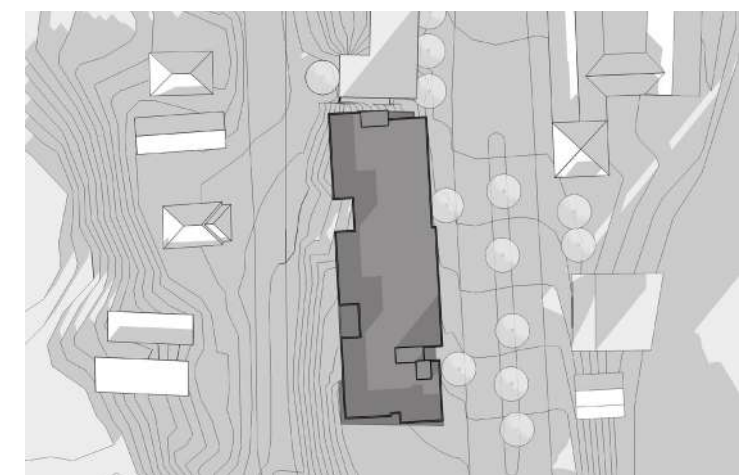
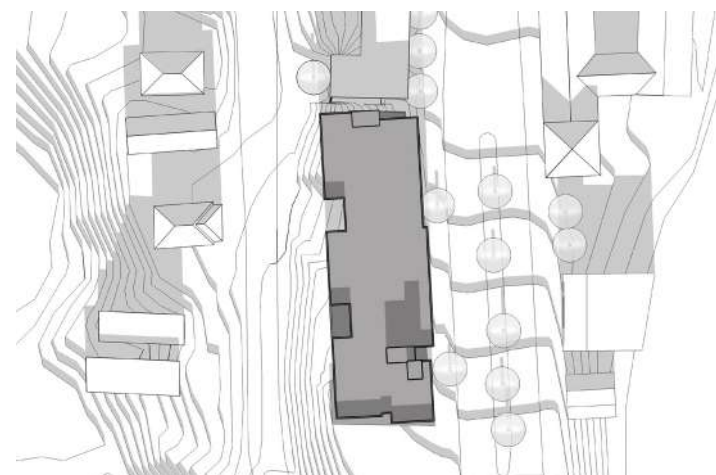
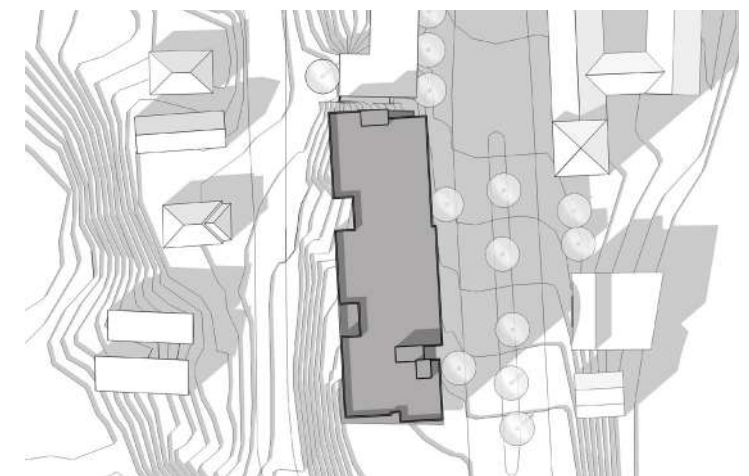
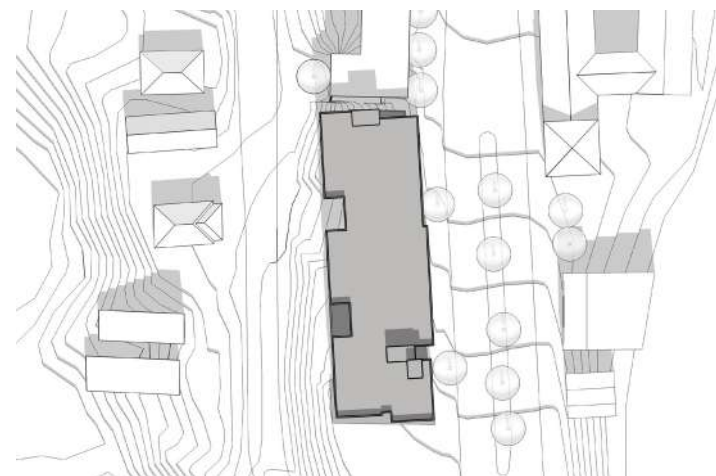
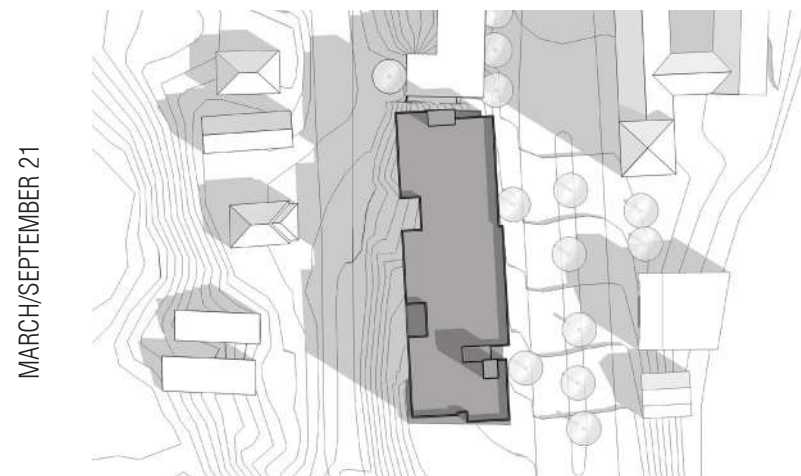
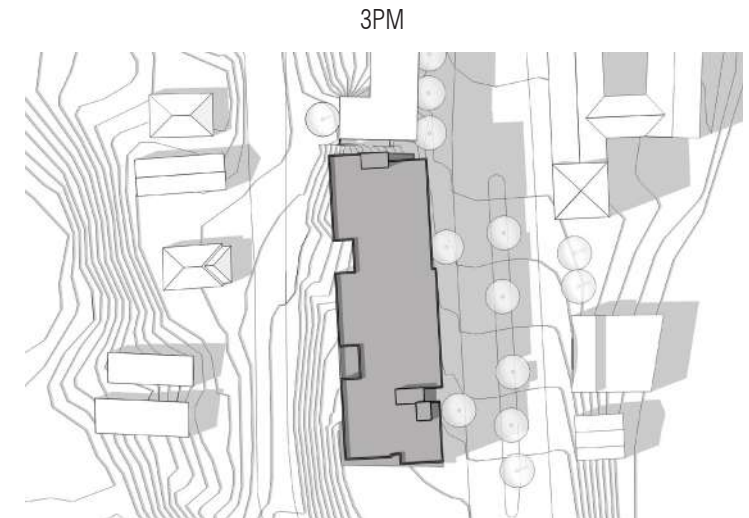
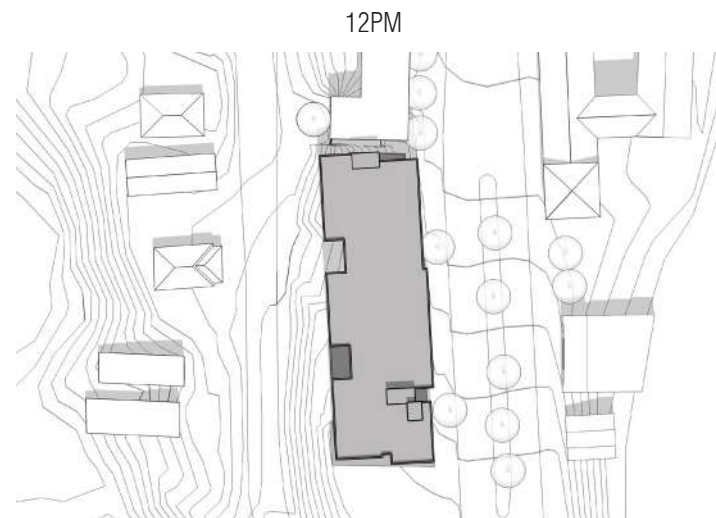
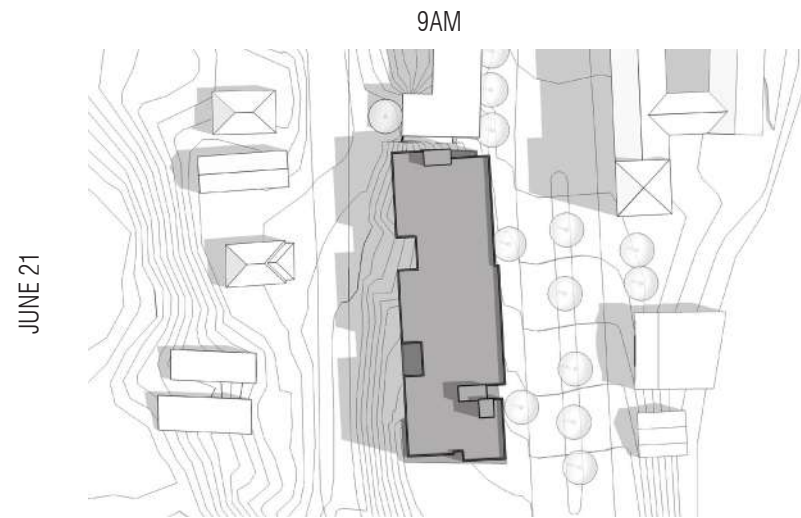

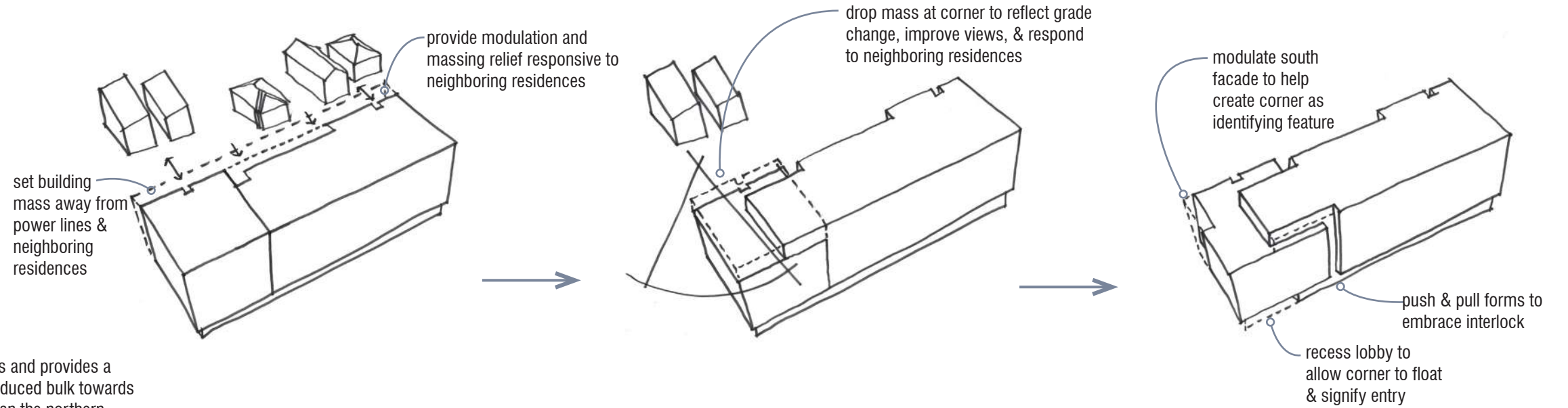
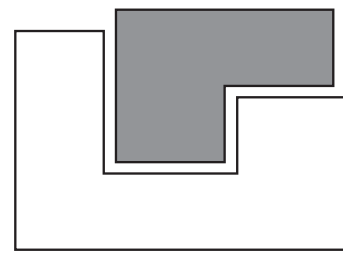

Scheme 3: INTERLOCK (PREFERRED)

Scheme 3 is the preferred scheme. It breaks up the building's mass and provides a landscaped courtyard element facing 30th Ave, while providing a reduced bulk towards the southern edge of the property. The southern mass is shorter than the northern masses, helping to create a transition in building scale and increasing the building's legibility. The lobby is located at the southern corner, with garage access off of Harbor Ave on the north end of the site.

NO. OF UNITS: 126 apartments
 PARKING: 71 stalls

BENEFITS:

- gestures towards the assumed corner shared with SPU property to the south.
- responds to site topography, stepping with the slope in the north and south direction
- locates the bulk of the massing away from the 30th Ave residential zone
- larger courtyard allows for usable landscaped areas for increased eyes on the street and connections with the neighborhood

CONCERNS:

- tallest portion of mass faces the adjacent neighboring multi-family building to the north

POTENTIAL DEPARTURES:

- exceptional tree
- street-level parking

COMMUNITY OUTREACH INTEGRATION:

- provide dog waste receptacles along 30th Ave
- significantly increased parking over code compliant proposal (42 parking stalls in "hinge" scheme)
- roof deck set back from edge of building
- large landscaped courtyard encourages engagement with residents of 30th Ave
- lower level terraces accommodates this engagement while setting the building back from property edge helps to maintain privacy of residential neighbors as requested



CONCEPT

This scheme embraces the site's transitions that occur through topography, zoning and neighborhood. It captures and responds to them, interweaving with push and pull, to create a building that is respectful and embracing of its surroundings.



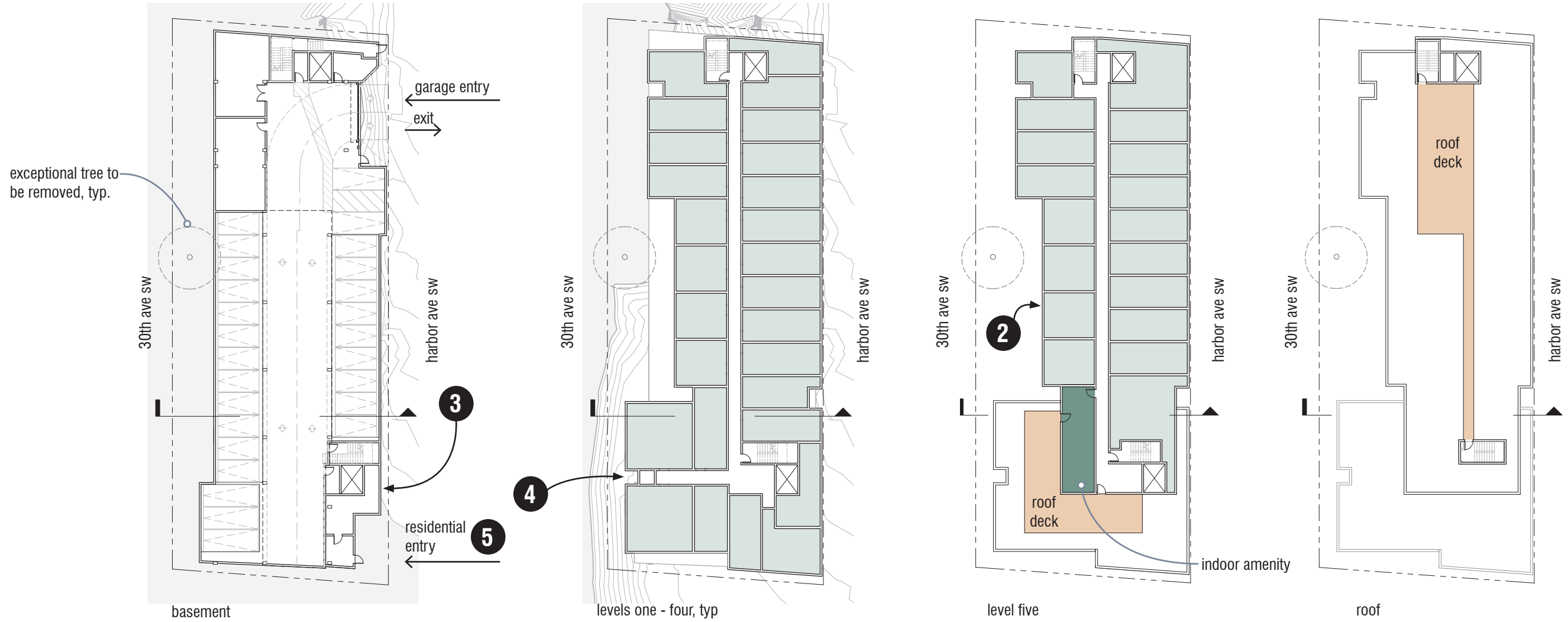

- 1 Stepped massing respects zone transition - CS2.D.3
- 2 Mass set back from property line respects adjacent sites - CS2.D.5
- 3 Recessing the ground floor at street edge allows for greater connection to street with landscape strip, seating, etc. - CS2.B.2
- 4 Massing choices include recesses along the residential facing mass - CS2.D.4
- 5 A recessed entry provides a welcoming yet safe entry sequence - PL3A.1.C

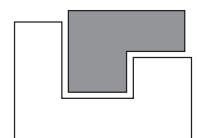
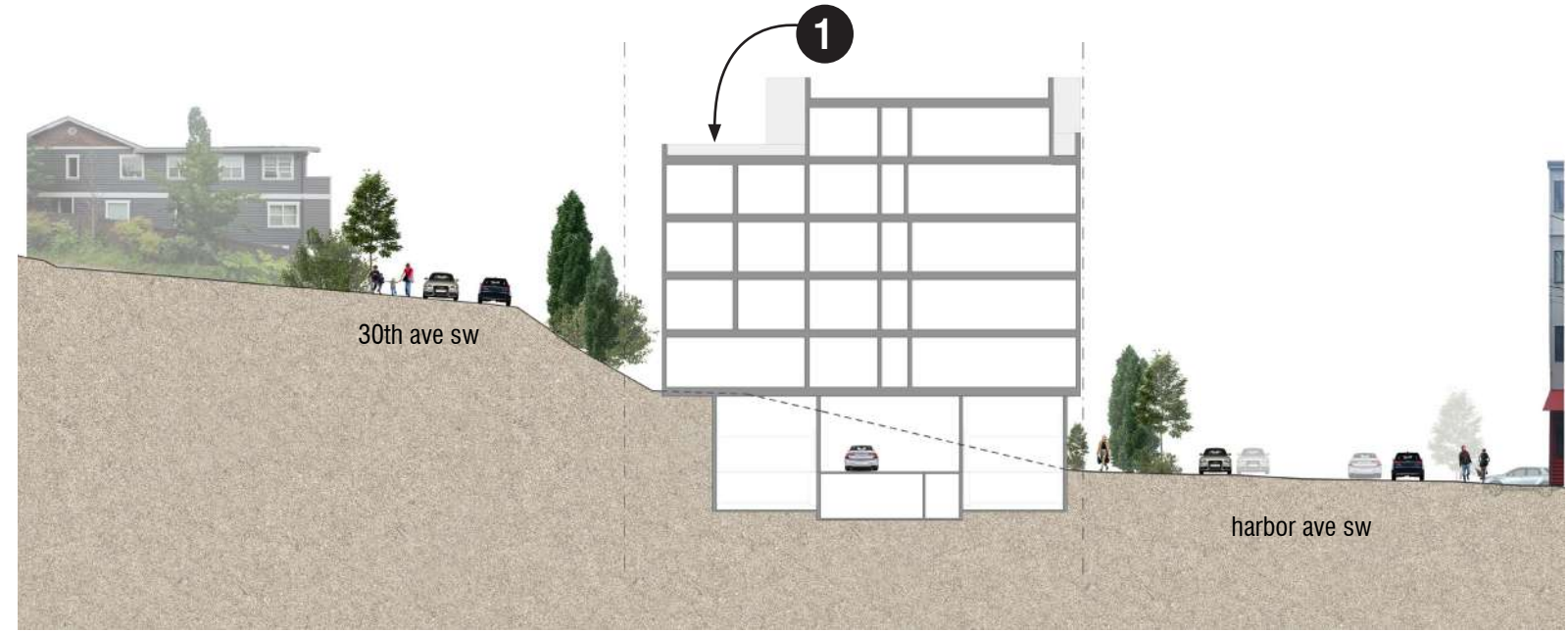

10.0 ARCHITECTURAL DESIGN CONCEPTS | scheme 3: interlock

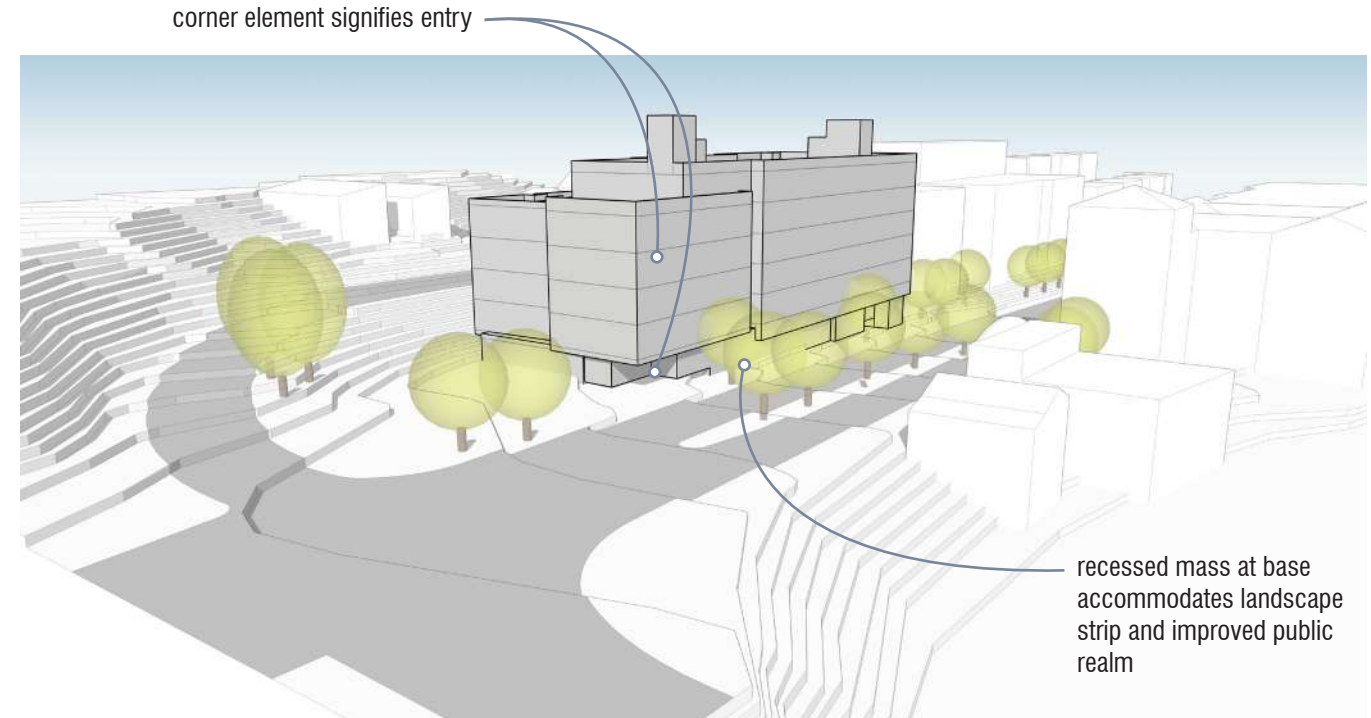

aerial view from West Seattle Bridge

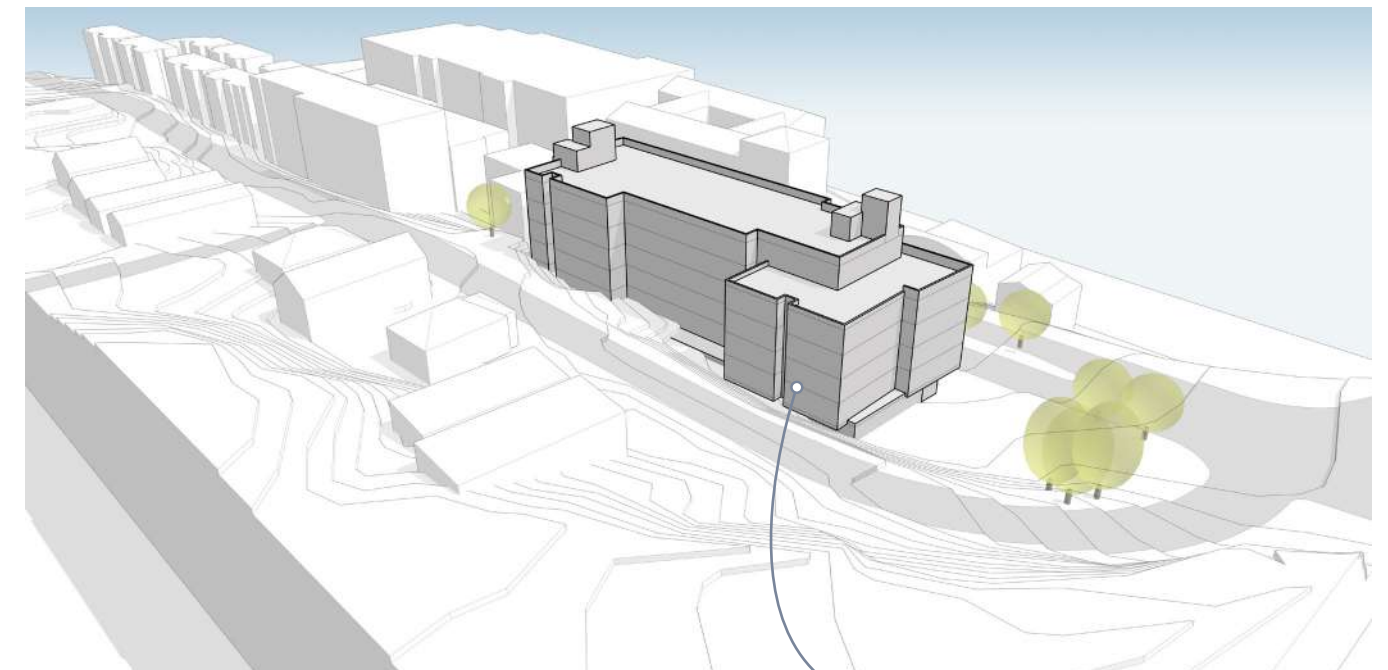

aerial view north along 30th Ave

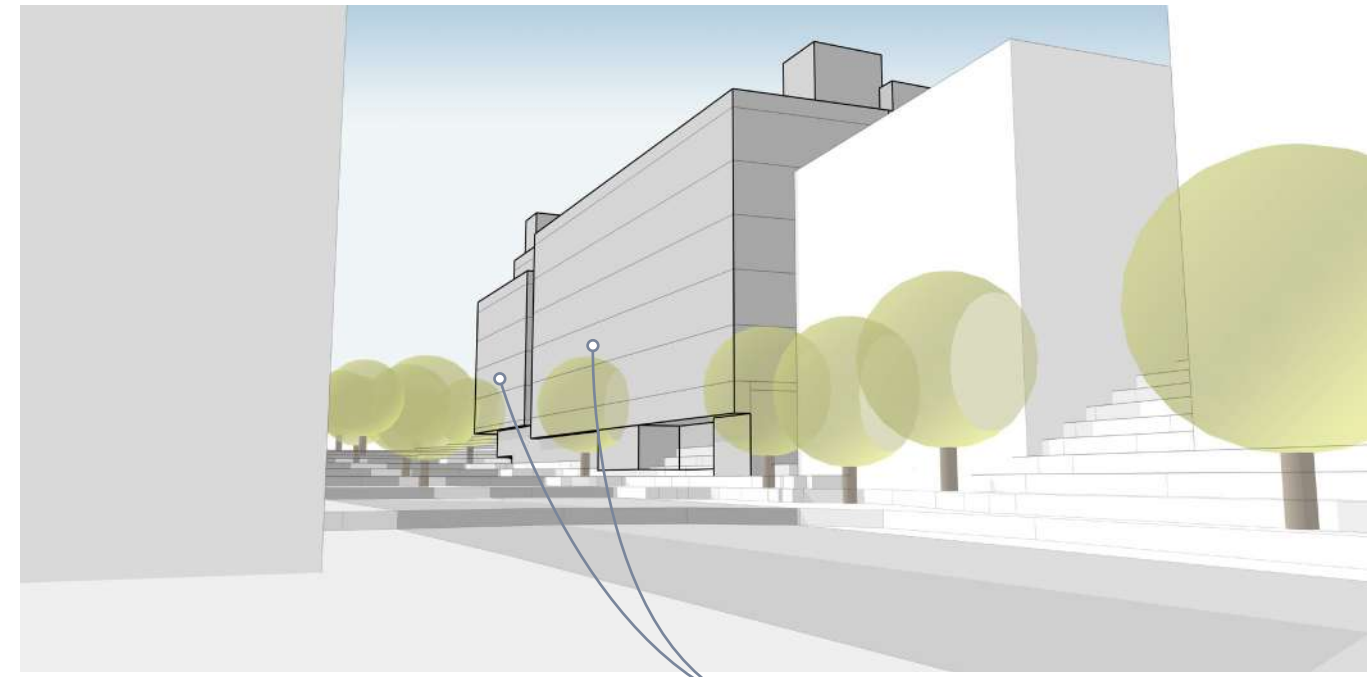

view of north corner from Harbor Ave

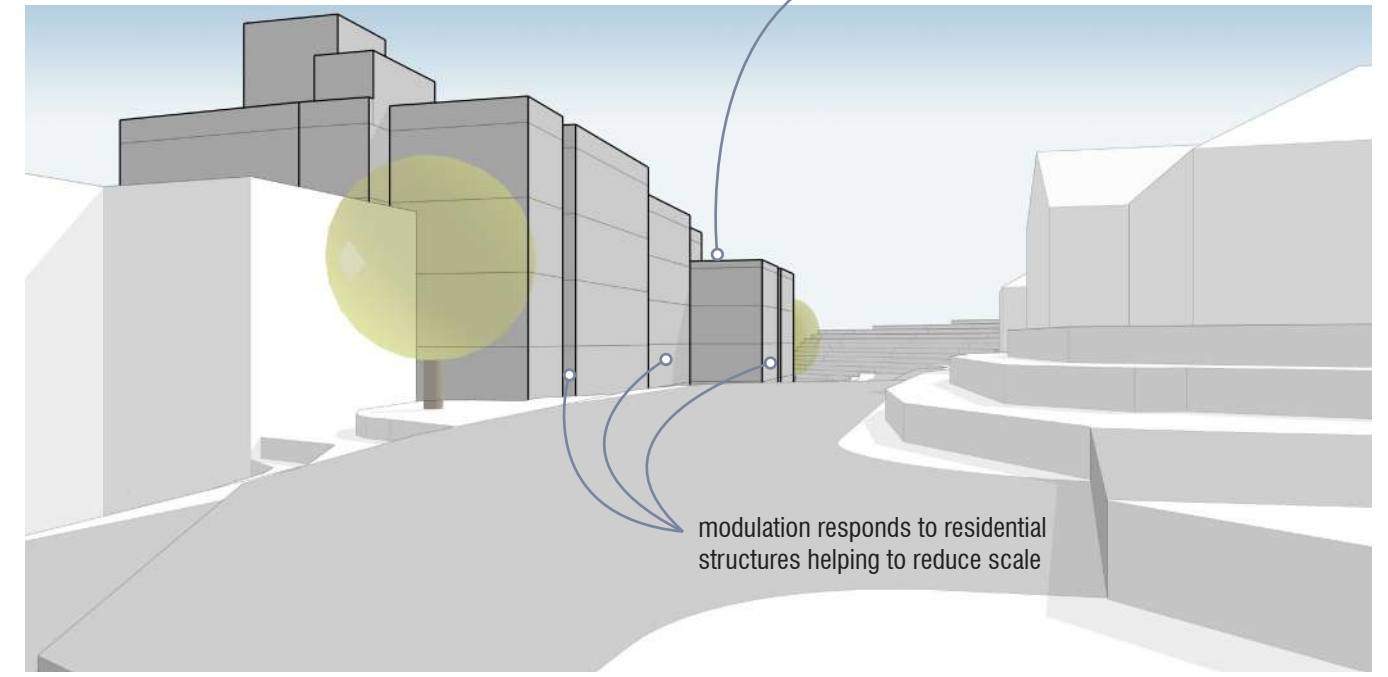

view from 30th looking south towards West Seattle Bridge

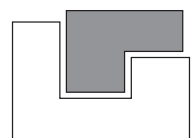

JUNE 21

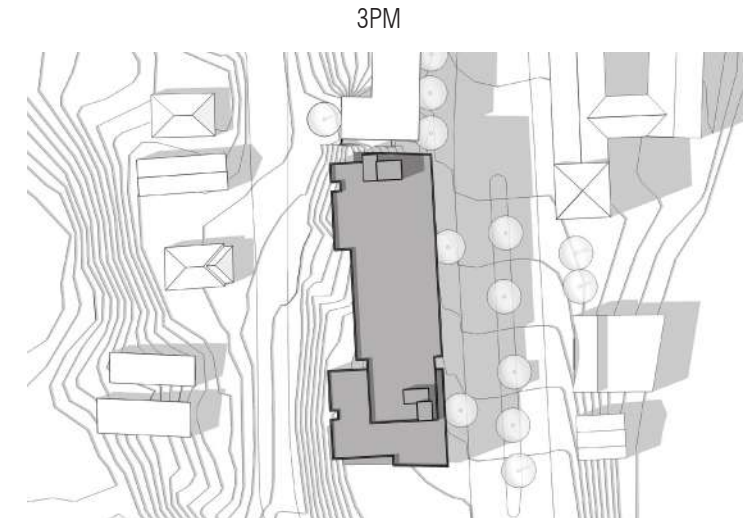
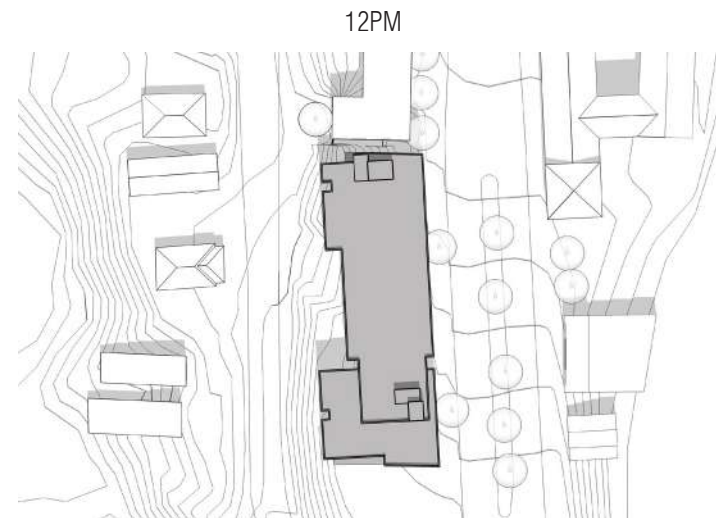
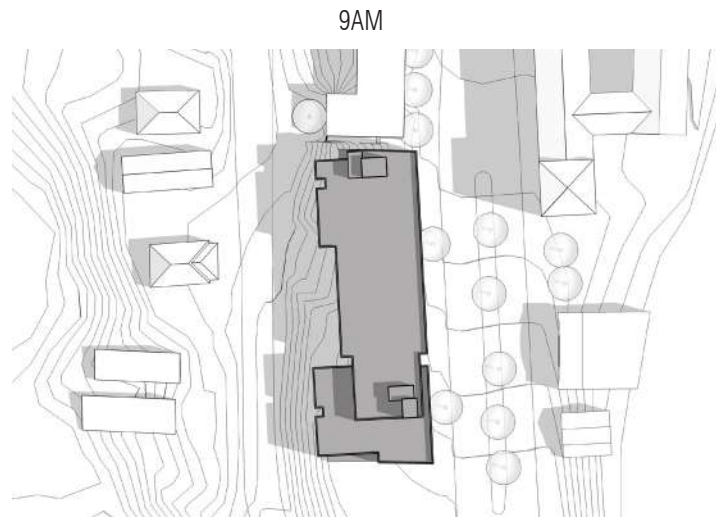

MARCH/SEPTEMBER 21

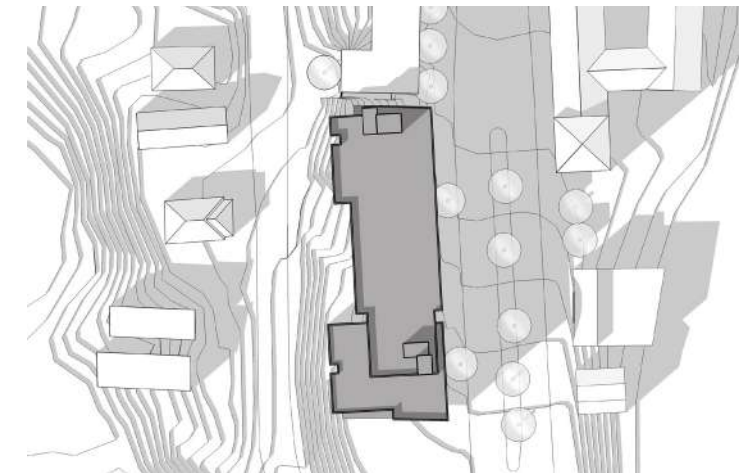
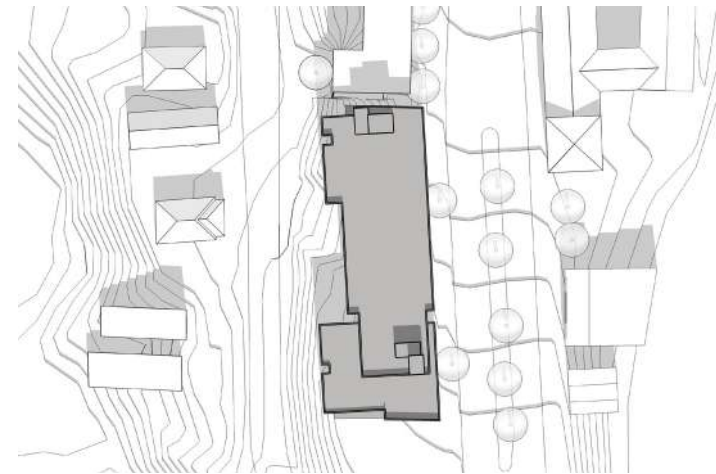
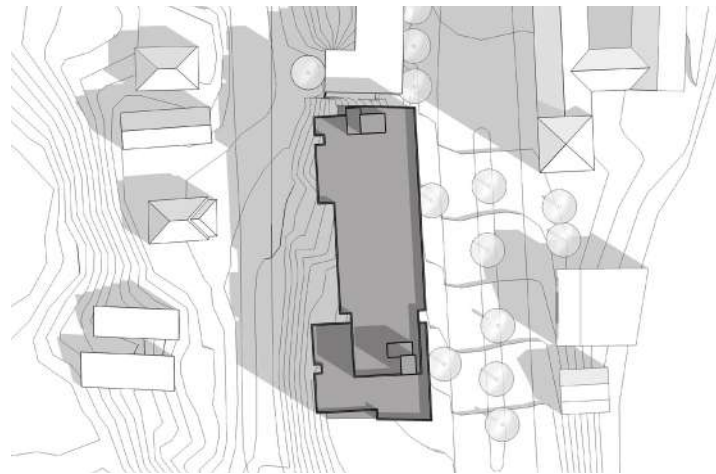

DECEMBER 21

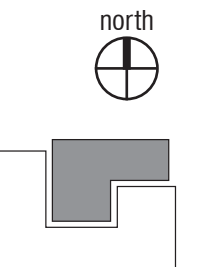
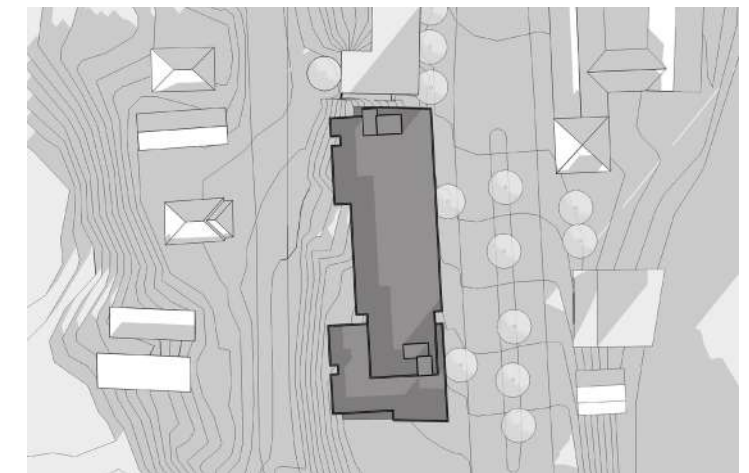
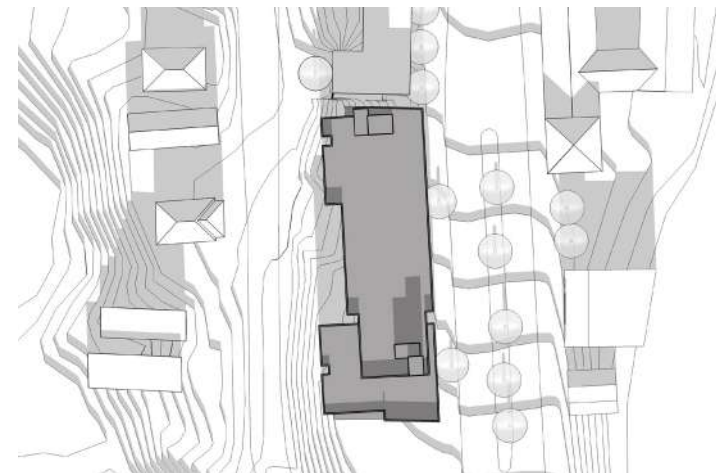
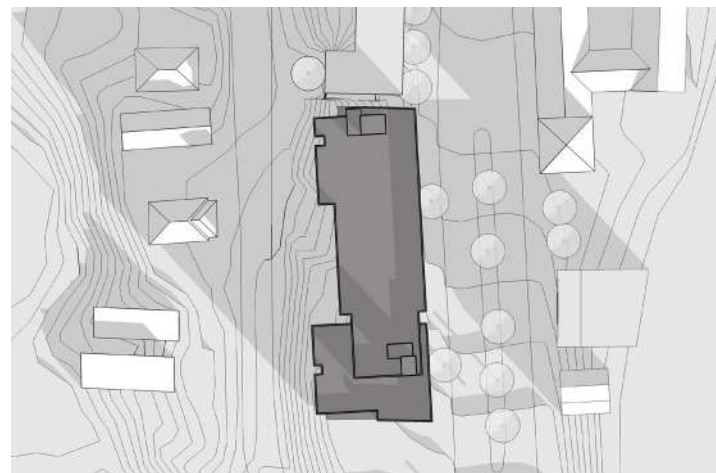

10.0 ARCHITECTURAL DESIGN CONCEPTS | landscape design concept - ground level

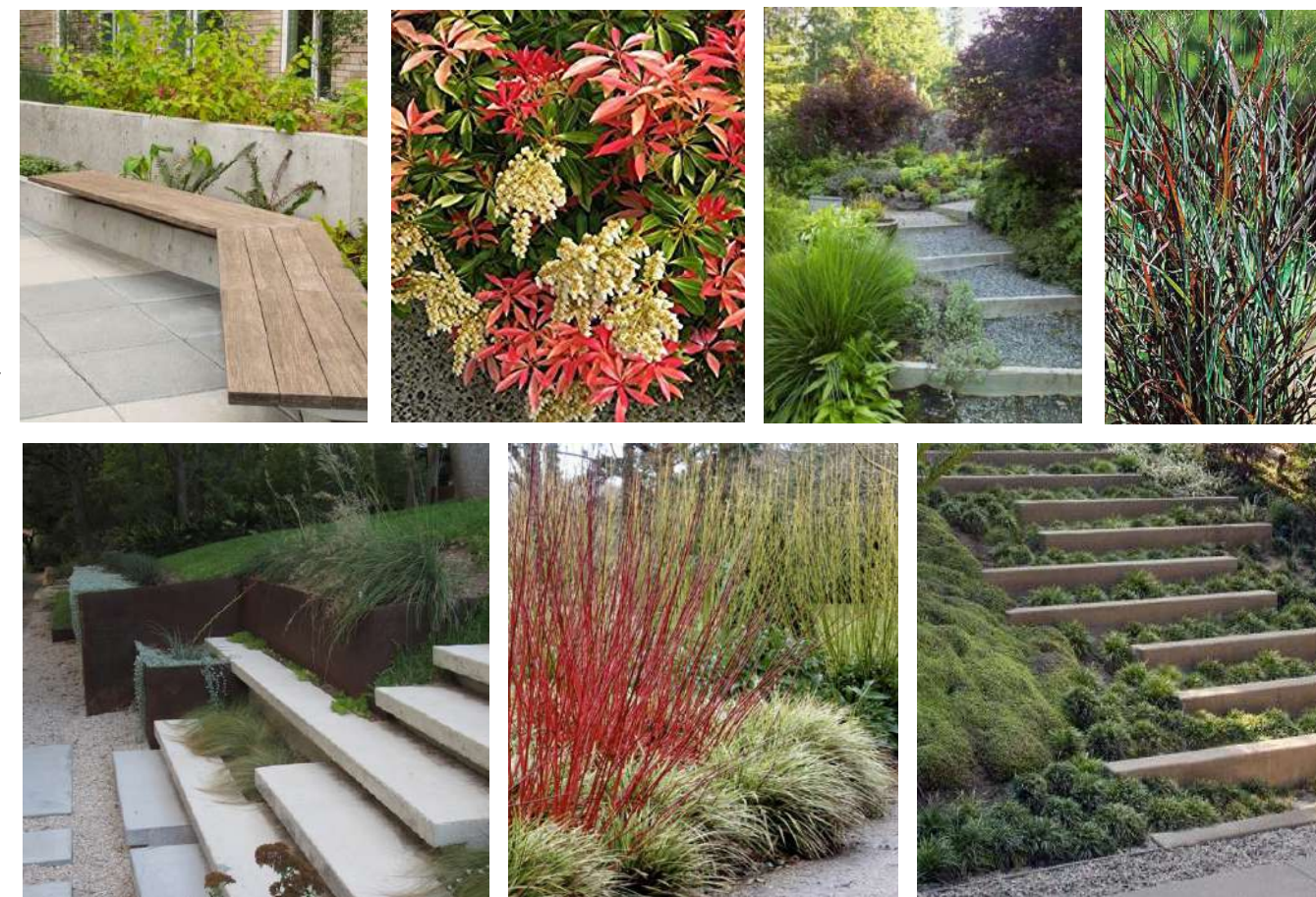
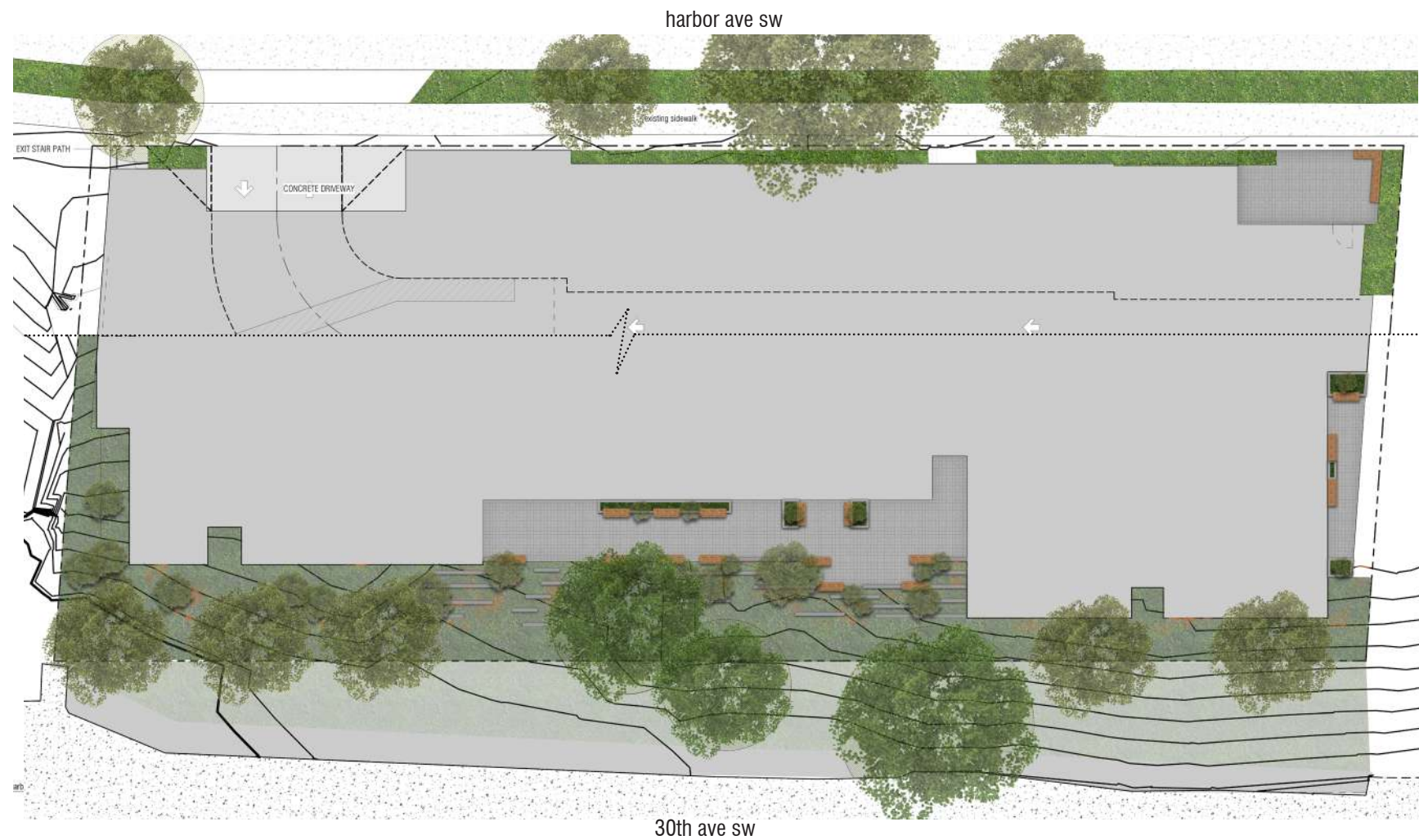

HARBOR AVENUE LANDSCAPE

- layers of textural evergreen and deciduous greens would provide a foundation along the building exterior with pops of color throughout
- there would be year-round seasonal interest with berries, flowers and changing foliage colors along with bright bark revealed when deciduous leaves fall away in the colder months
- a welcoming corner entry plaza features a special paving pattern to signal the entry to passersby on the sidewalk along with a welcoming two-sided bench

30TH AVENUE LANDSCAPE

- layers of textural greens with a mix of evergreen and deciduous plants to integrate with the neighborhood character and add seasonal interest
- terraced areas surround the patio with linear steps that pull from the rhythm of the building and erode up the hillside, melting in with lush planting material and providing opportunity for community interaction
- the landscape would include pops of bright color throughout the seasons like berries, flowers and bark for year-round interest

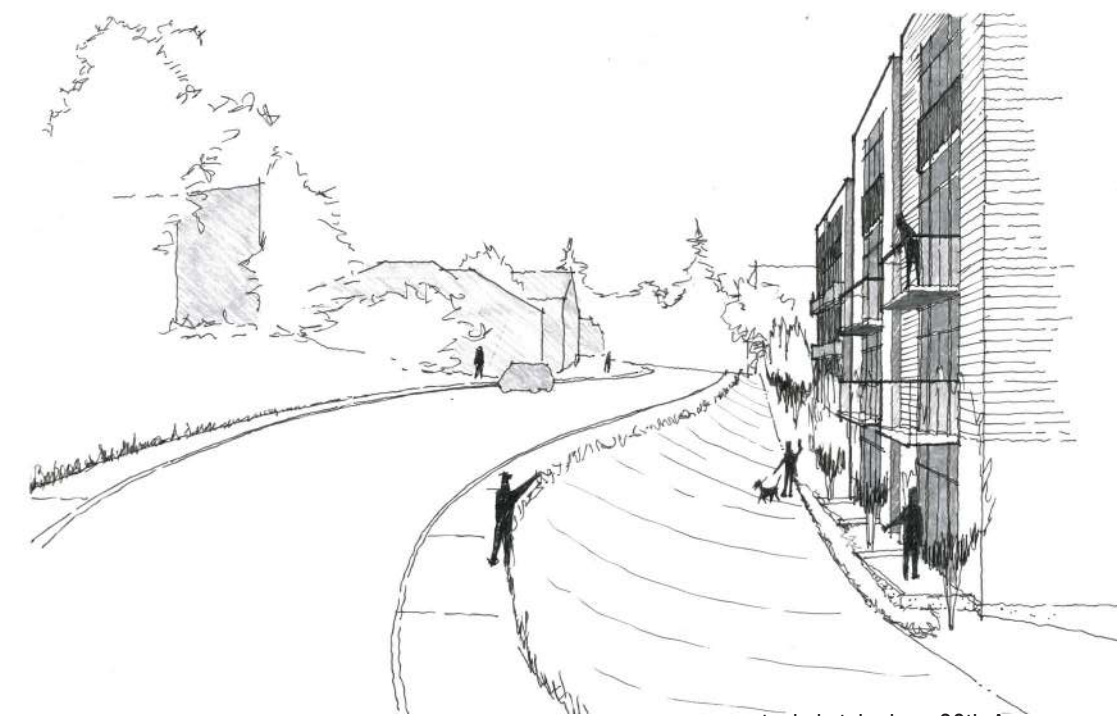

conceptual sketch along 30th Ave

harbor ave sw



30th ave sw

ACCESSIBLE ROOF DECKS

- space includes amenities for residents such as a grilling area, various sizes of tables, lounge chairs and views outward
- swaths of flowering ground covers, sweeping grasses, succulents and evergreens
- planters with small trees divide spaces to allow for multiple configurations and users

INACCESSIBLE VEGETATED ROOF

- undulating swaths of succulents provide habitat and additional food sources for pollinator species and birds, assist in stormwater infiltration and urban heat island reduction
- provide pleasing vegetated views for the neighbors on the east and north side of the building as well as looking down from above



EXCEPTIONAL TREE

SMC23.47A.008.2

REQUIREMENT

Exceptional trees must be retained and protected during construction in the City of Seattle.

REQUEST

We request removal of one exceptional tree, a big leaf maple, that is in poor health, and to replace it with a tree that will provide the same canopy coverage at maturity.

RATIONALE

The existing maple is unfortunately in poor condition from lack of maintenance and inappropriate pruning over the years. It has been topped; the trunk is covered in thick ivy and blackberry vines. The canopy is also filled with broken and dead branches. All of these elements have contributed to the tree's poor state. Removing the tree will allow for healthy growth of new trees and plants on the site. A healthy existing tree is proposed to be moved to a similar area to maintain some of the existing mature growth.

Maintaining this unhealthy tree will require a reduction of parking due to the required shoring. Because the tree will likely not survive much longer (with or without the effects of new construction), this is an unreasonable trade-off. Additionally, because an existing tree's roots cannot be buried nor uncovered and still maintain the health of the tree, the existing steeply sloping site would remain.

By removing the tree, the design would be able to gently re-grade the site at the courtyard, allowing for a more usable and active outdoor space. This would provide amenity space at grade for the residents and an improved connection between the building's residents and the neighbors along 30th Ave. Removing the tree will both allow for increased parking as the neighborhood has requested, but will more importantly allow for more natural and mature landscaping and an improved connection to the residential zone.

APPLICABLE SCHEMES

Scheme 2 (dado)
Scheme 3 (interlock)

RELATED DESIGN GUIDELINES

DC2.A1 site characteristics & uses
DC2.A2 reduced perceived mass
DC3.C2 amenities & features
DC3.C3 support natural areas

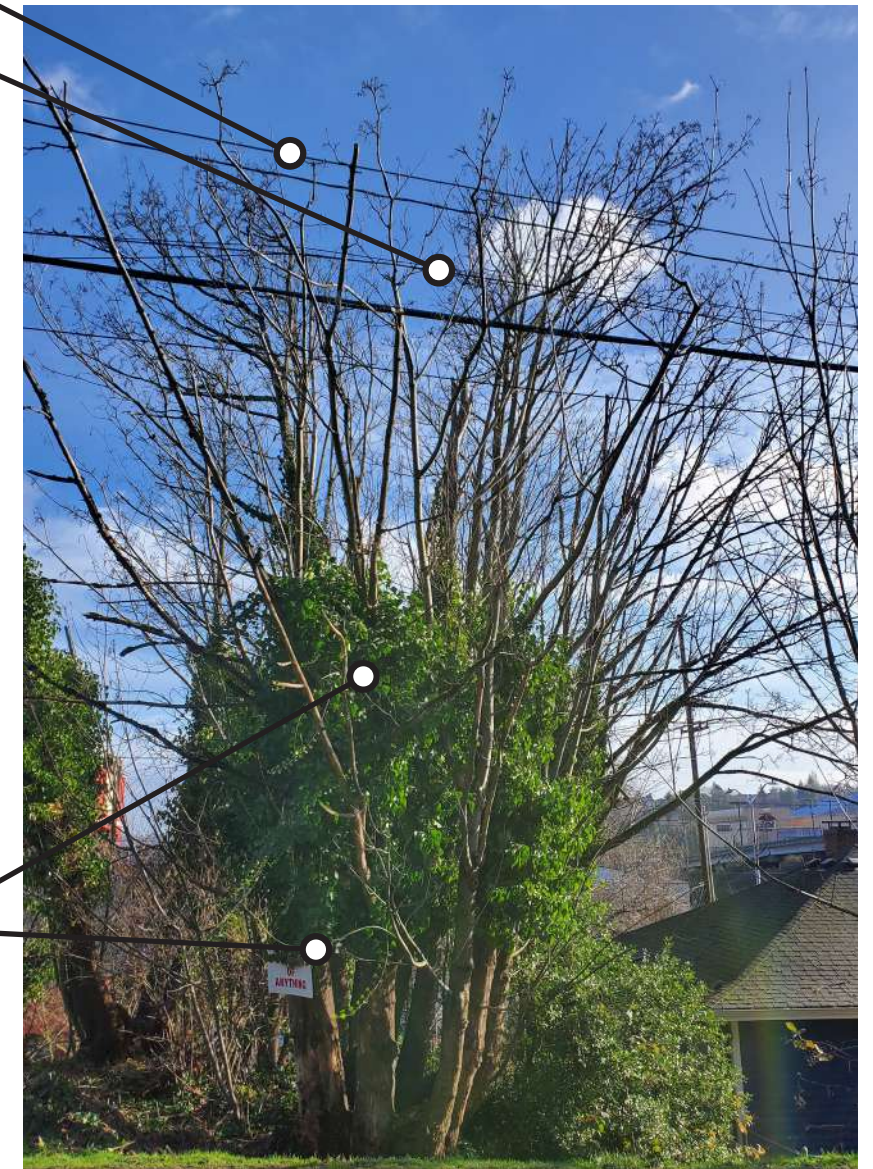
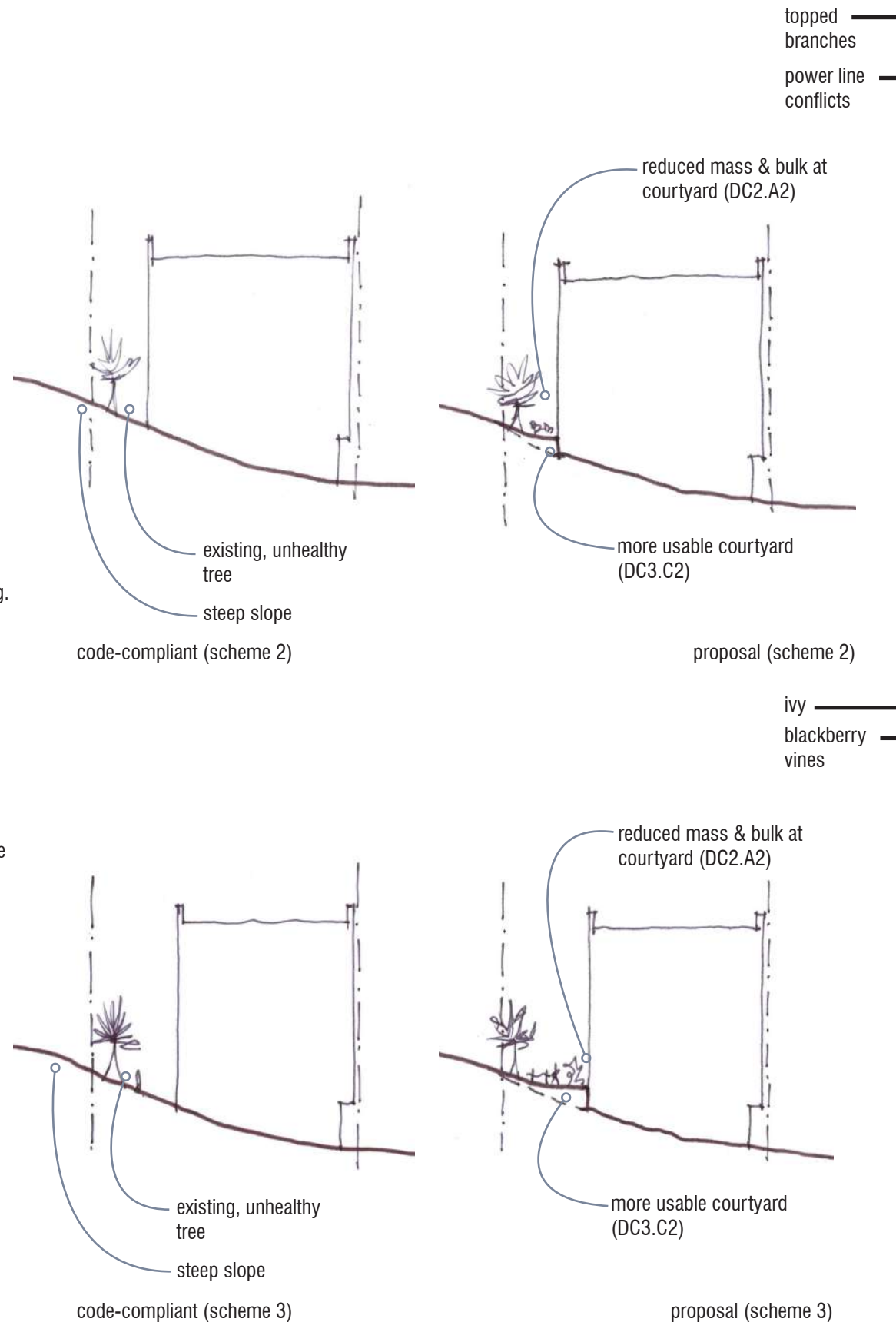

The existing big leaf maple, *acer macrophyllum*, that is located on the west side of the site. The maple has been poorly maintained and topped many times. In addition to being topped, an overgrowth of ivy, blackberry vines, and tangled power lines have contributed to its poor condition. This poor condition has been verified by a certified arborist.

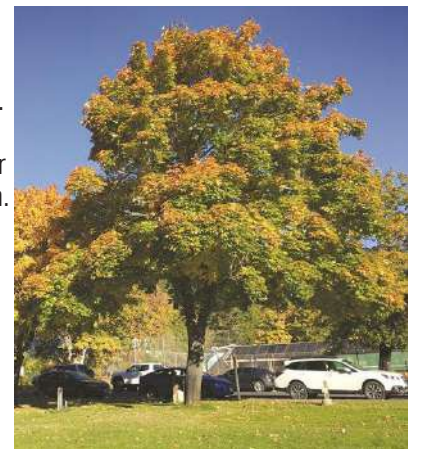

A healthy big leaf maple

STREET-LEVEL PARKING

SMC23.47A.032.B.2

REQUIREMENT

Enclosed parking provided at street-level must be separated from street-level, street facing facades by another permitted use.

REQUEST

We request street-level parking to be provided without separation from the street-level, street facing facade.

RATIONALE

Providing a permitted use in front of the street-level parking will push the edge of the building to the property line. The parking cannot be further pushed westward due to shoring constraints. By allowing the garage to be along the street-facing facade, the edge of the building can be stepped back from the property line to allow a separation between the building and sidewalk. This modulation provides an opportunity for visual interest which enhances the pedestrian experience and space.

Rather than provide a hard edge wall at the sidewalk, a landscaped and pedestrian oriented buffer accommodates integrated seating, avoids a foreboding building edge, and provides a more viable separation between the garage and street.

The intent of the code is to provide separation between the street/sidewalk and the parking area. The proposed relief at the sidewalk provides a more successful separation for both pedestrians and users.

APPLICABLE SCHEMES

Scheme 2 (dado)

Scheme 3 (interlock)

RELATED DESIGN GUIDELINES

CS2.B2 connection to the street

PL1.A1 enhancing open space

DC2.D2 texture

DC3.C2 amenities & features

without modulation and relief, street frontage is foreboding and monotonous

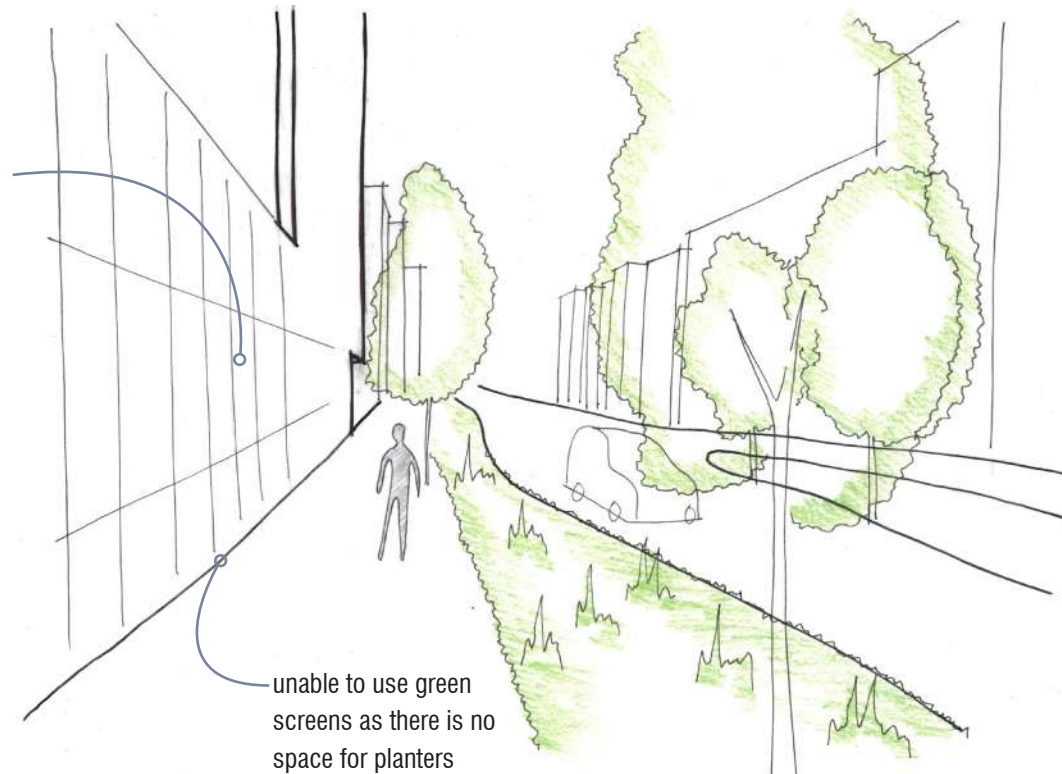

unable to use green screens as there is no space for planters

code-compliant (scheme 1)

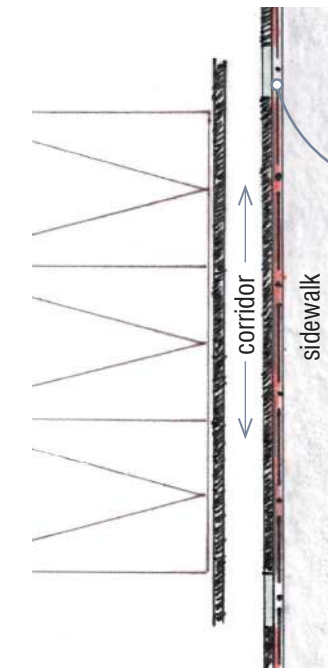

windows will still be minimal & screens will be mostly used to meet blank facade requirements due to lack of view into corridor

recessed facade allows for modulation and texture along ground floor (DC2.D2)

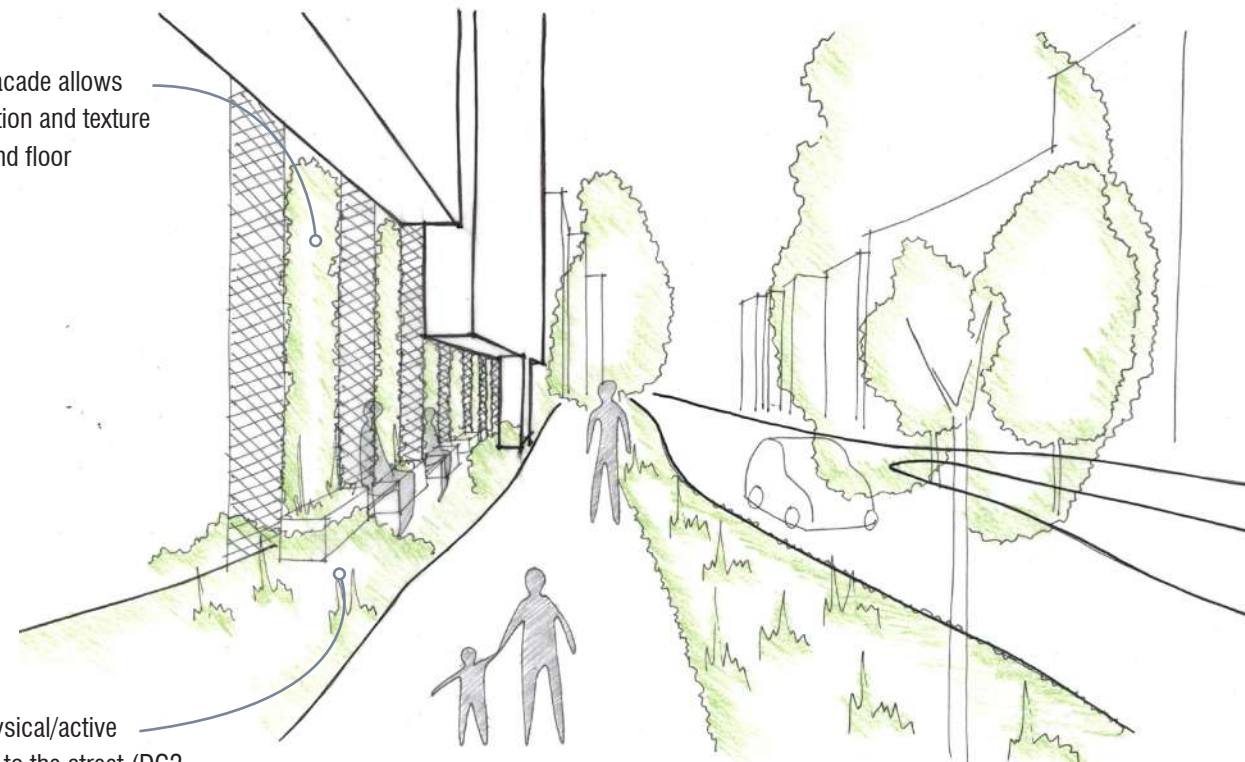

provide physical/active connection to the street (DC2.D2) by enhancing existing open spaces (PL1.A1) and providing attractive amenities and features

proposal (schemes 2 & 3)

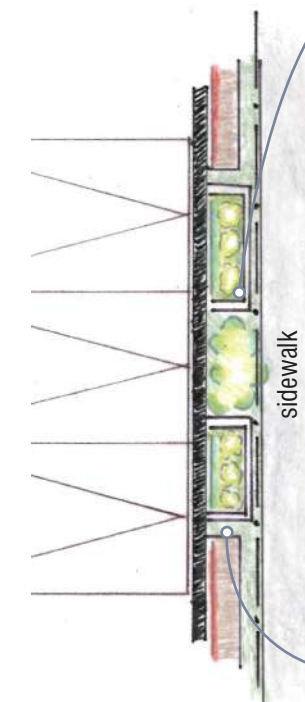

inclusion of mixture of materials such as screens & green walls, to provide visual interest & variety

benches & plantings provide public amenities

MATERIAL EXPLORATIONS

The project is exploring durable, quality materials that can be used to create simple rhythms and considering community feedback regarding material palette. More commercial and larger scale materials will be used facing Harbor Ave to respond to the tougher nature of the industrial zone. Smaller scale materials typically used in residential projects will be used across the 30th Ave facade to mimic the lower scale development.



vertical fiber cement siding



textured siding



variations in material application



pops of color



variations in material scale

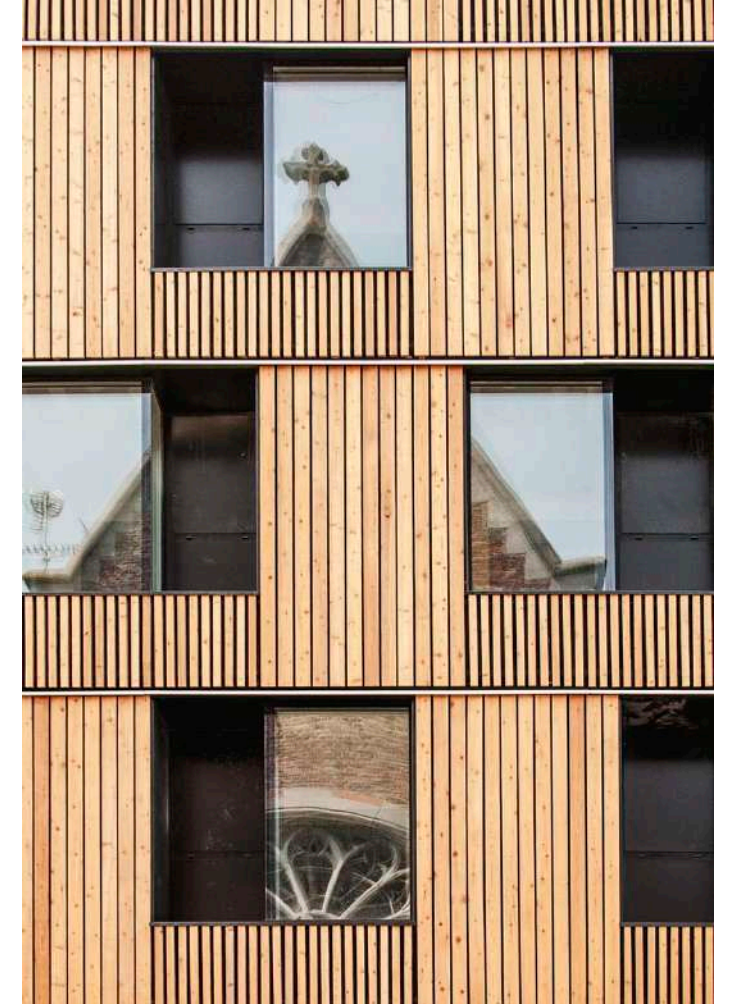

wood accents



attention to detail



Careful transitions



patterns with materials



color as wayfinding



playful siding



industrial materials



distinct graphics



pattern hierarchy

BLANK FACADE EXPLORATIONS

Per SMC23.47A.008, street-level facades are considered blank if they do not contain windows, entry/doorways, stairs/stoops/porticos, decks, balconies, screening, or landscaping on the facade. Locating the parking at the basement level minimizes the visual impact of the parking on the majority of the facades, but presents a design challenge on the Harbor Ave facade - a site long concrete wall.

Projects have found many ways to break up the length of concrete wall typically associated with a parking garage. As all three design schemes would be impacted, the project is exploring effective methods to provide modulation or visual interest without the use of glazing. These methods could include textured concrete, decorative metal screens, or landscaped green walls, but will likely include a combination of these elements. A departure is not needed for these treatments.

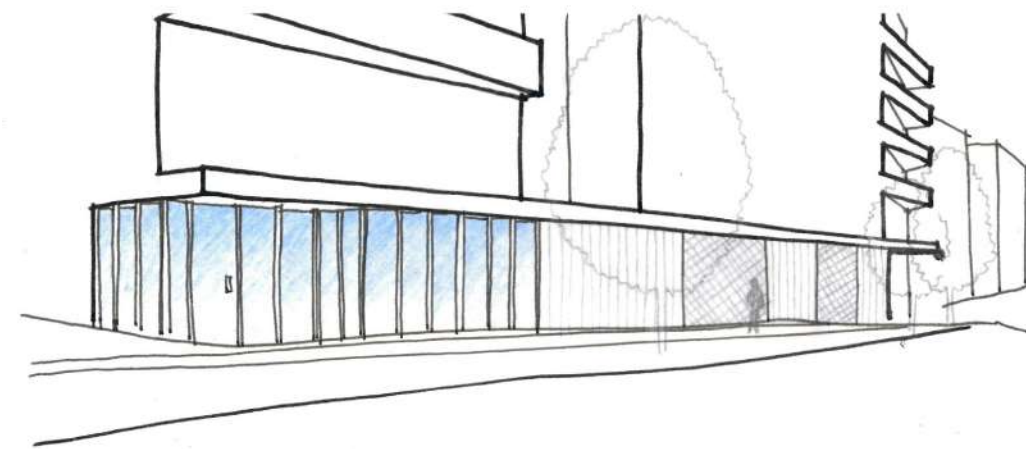

facade concept sketch - scheme hinge

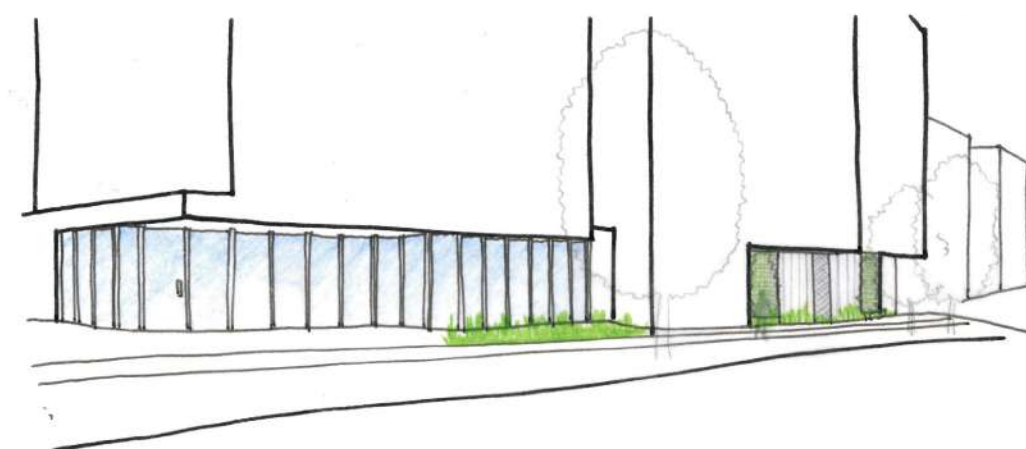

facade concept sketch - scheme dado

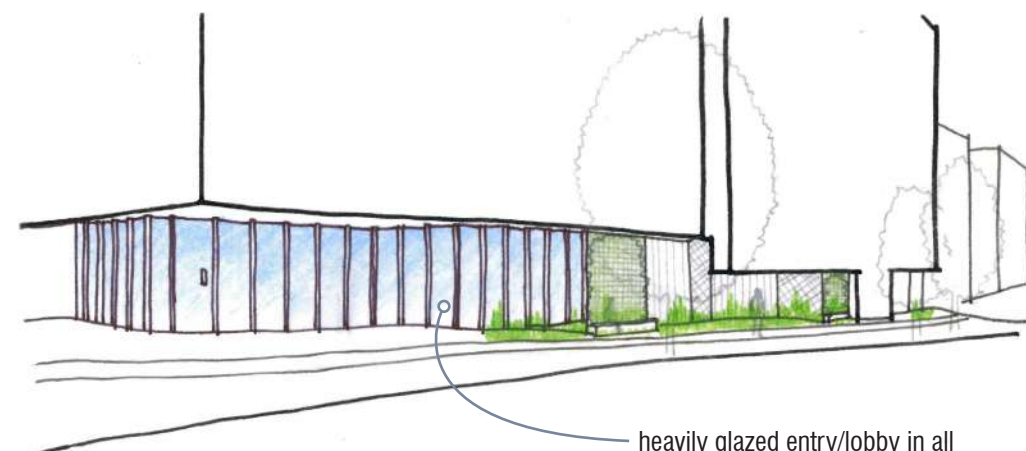

facade concept sketch - scheme interlock

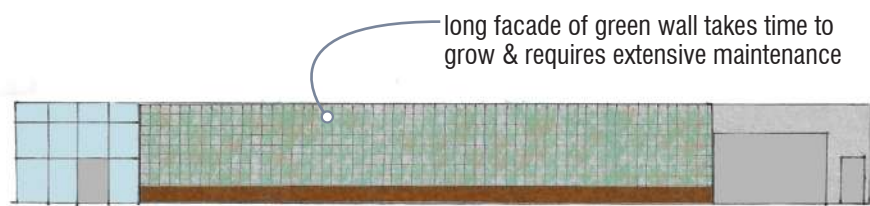

long facade of green wall takes time to grow & requires extensive maintenance

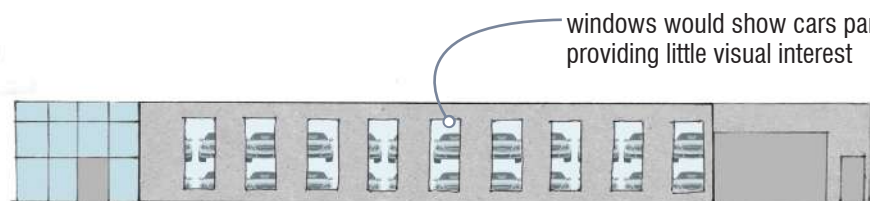

windows would show cars parked, providing little visual interest

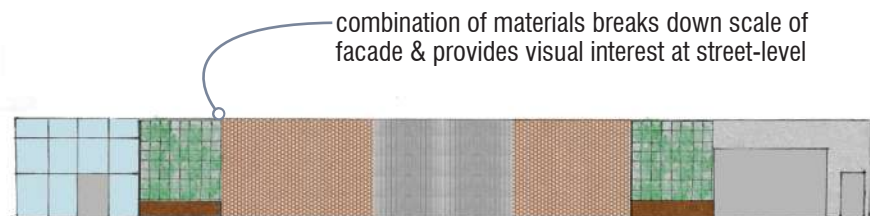

combination of materials breaks down scale of facade & provides visual interest at street-level

diagrammatic concept studies



decorative screen



green wall



green/living wall



decorative screen



patterned concrete



mural (there is a rich history of murals in West Seattle)

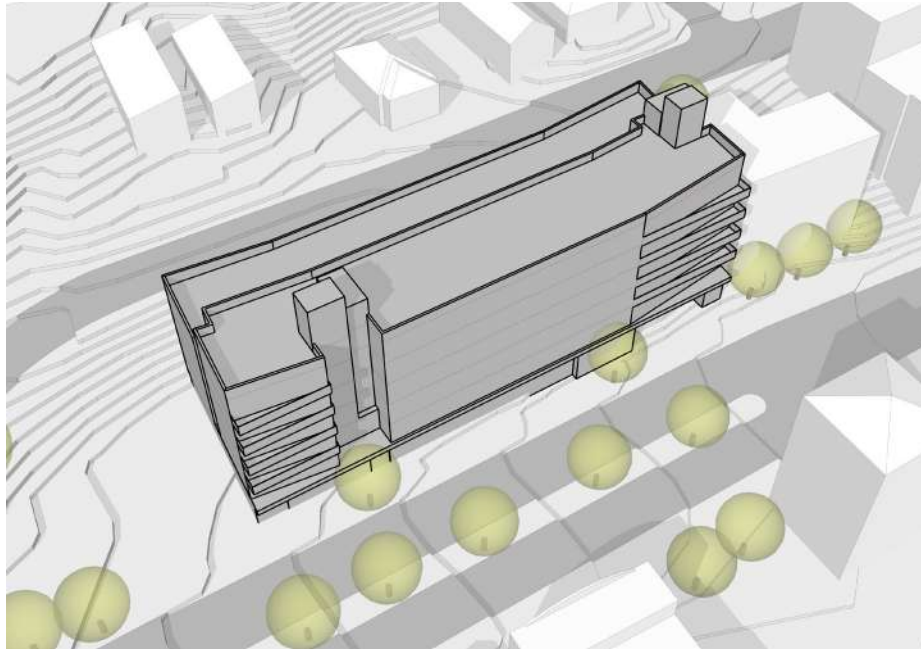

SCHEME 1: HINGE (CODE COMPLIANT)

Scheme 1 is a zoning compliant scheme that primarily maintains the hard line building frontage along Harbor Ave, with the hinge points providing clipped corners for relief in the mass. Along 30th Ave, the building embraces the existing exceptional tree and accommodates a landscaped courtyard facing the residential zone. The building mass steps back from the residential zone in order to provide additional relief. The lobby is located at the southeast corner of the building, with the garage access at the northeast corner.

NO. OF UNITS: 134 apartments
 PARKING: 42 stalls

BENEFITS:

- provide bulk of massing along eastern edge fronting the commercial/industrial zone
- steps building away from residential zone

CONCERNS:

- massing does not step with the grade
- a blank hallway faces the residential zone at the upper level
- little to no variation and modulation along length of building, particularly fronting 30th Ave
- no relief at Harbor Ave streetscape
- significantly reduced parking

POTENTIAL DEPARTURES:

- none

COMMUNITY OUTREACH INTEGRATION:

- upper floor is facing Harbor Ave, instead of looming over 30th Ave, for increased privacy for neighbors
- provide dog waste receptacles along 30th Ave

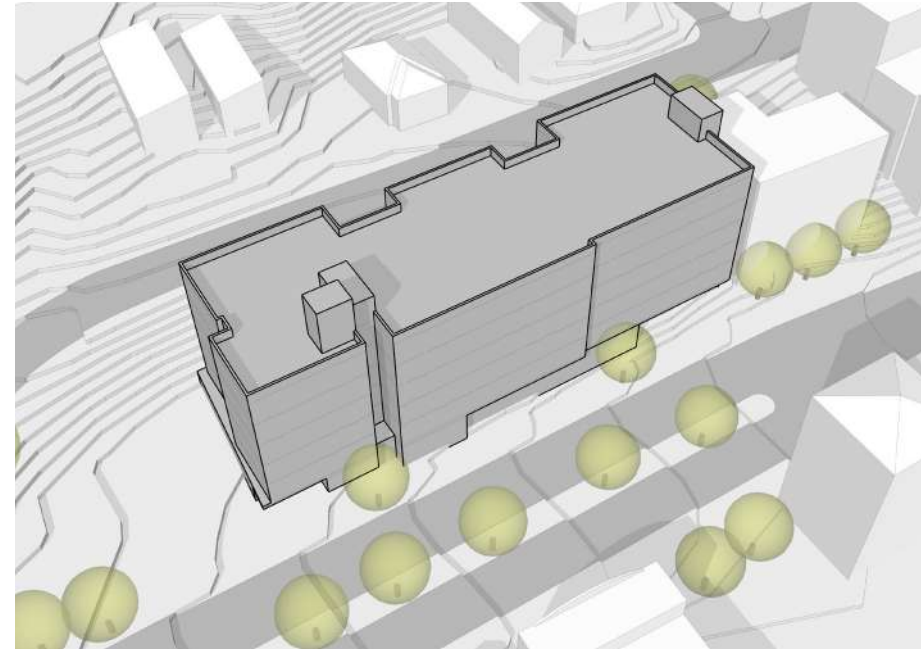

Scheme 2: DADO

Scheme 2 maximizes the building's frontage along Harbor Ave, and modulates the massing to respond to the residential neighbors along 30th Ave. The lobby is located at the southeastern corner of the building with the garage access off of Harbor Ave on the northeastern end of the site.

NO. OF UNITS: 140 apartments
 PARKING: 68 stalls

BENEFITS:

- maximizes light and views to the east.
- provides a modulated massing facing the residential zone.

CONCERNS:

- little to no variation and modulation along the Harbor Ave facade.
- height and bulk of the building is maintained on the residential side and zone
- windows within interior courtyards facing north and south will receive little direct light due to narrow width

POTENTIAL DEPARTURES:

- exceptional tree
- street-level parking

COMMUNITY OUTREACH INTEGRATION:

- provide dog waste receptacles along 30th Ave
- increased parking over code compliant scheme (42 parking stalls in the "hinge" scheme)

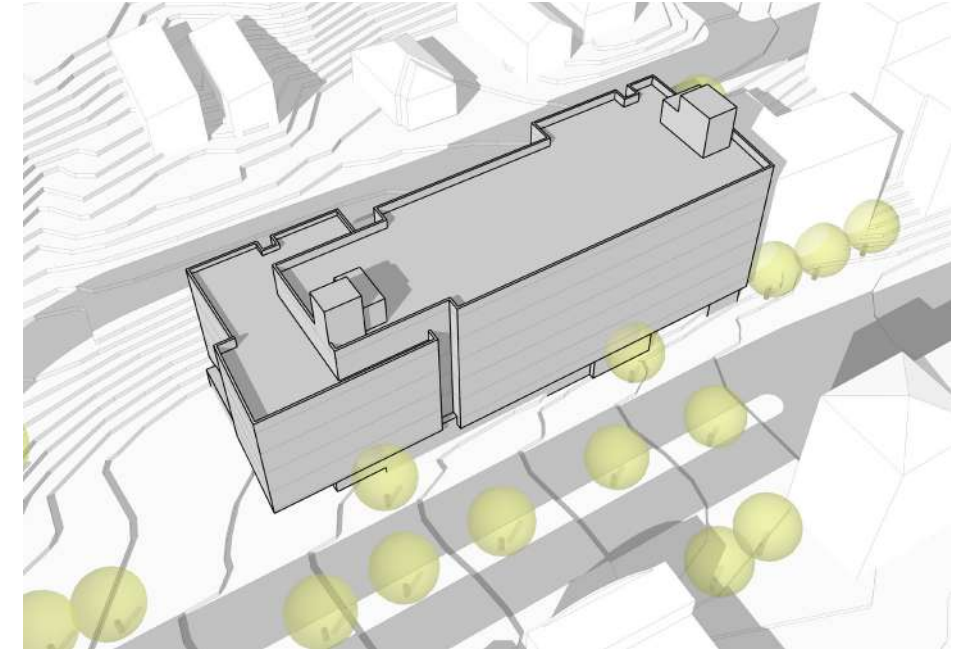

Scheme 3: INTERLOCK (PREFERRED)

Scheme 3 is the preferred scheme. It breaks up the building's mass and provides a landscaped courtyard element facing 30th Ave, while providing a reduced bulk towards the southern edge of the property. The southern mass is shorter than the northern masses, helping to create a transition in building scale and increasing the building's legibility. The lobby is located at the southern corner, with garage access off of Harbor Ave on the north end of the site.

NO. OF UNITS: 126 apartments
 PARKING: 71 stalls

BENEFITS:

- gestures towards the assumed corner shared with SPU property to the south.
- responds to site topography, stepping with the slope in the north and south direction
- locates the bulk of the massing away from the 30th Ave residential zone
- larger courtyard allows for usable landscaped areas for increased eyes on the street and connections with the neighborhood

CONCERNS:

- tallest portion of mass faces the adjacent neighboring multi-family building to the north

POTENTIAL DEPARTURES:

- exceptional tree
- street-level parking

COMMUNITY OUTREACH INTEGRATION:

- provide dog waste receptacles along 30th Ave
- significantly increased parking over code compliant proposal (42 parking stalls in "hinge" scheme)
- roof deck set back from edge of building
- large landscaped courtyard encourages engagement with residents of 30th Ave
- lower level terraces accommodates this engagement while setting the building back from property edge helps to maintain privacy of residential neighbors as requested

